

5V High Efficiency Step-Down Switching Regulator Controller

FEATURES

- Accurate Preset +5V Output
- Up to 90% Efficiency
- Optional Burst Mode for Light Loads
- Can be Used with Many LTC Switching ICs
- Accurate Ultra-Low-Loss Current Limit
- Operates with Inputs from 6V to 30V
- Shutdown Mode Draws Only 15 μ A
- Uses Small 50 μ H Inductor

APPLICATIONS

- Laptop and Palmtop Computers
- Portable Data-Gathering Instruments
- DC Bus Distribution Systems
- Battery-Powered Digital Widgets

DESCRIPTION

The LT1432 is a control chip designed to operate with the LT1170/LT1270 family of switching regulators to make a very high efficiency 5V step-down (buck) switching regulator. A minimum of external components is needed.

Included is an accurate current limit which uses only 60mV sense voltage and uses “free” PC board trace material for the sense resistor. Logic controlled electronic shutdown mode draws only 15 μ A battery current. The switching regulator operates down to 6V input.

The LT1432 has a logic controlled “burst” mode to achieve high efficiency at very light load currents (0 to 100mA) such as memory keep-alive. In normal switching mode, the standby power loss is about 60mW, limiting efficiency at light loads. In burst mode, standby loss is reduced to approximately 15mW. Output current in this mode is typically in the 5mA to 100mA range.

The LT1432 is available in 8-pin surface mount and DIP packages. The LT1170/LT1270 family will also be available in a surface mount version of the 5-pin TO-220 package. For 3.3V versions contact Linear Technology Corporation.

TYPICAL APPLICATION

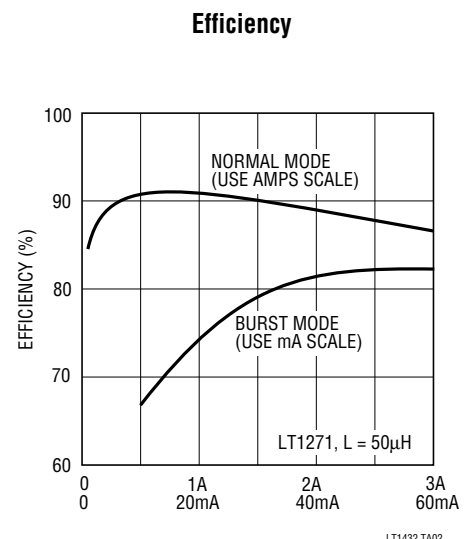
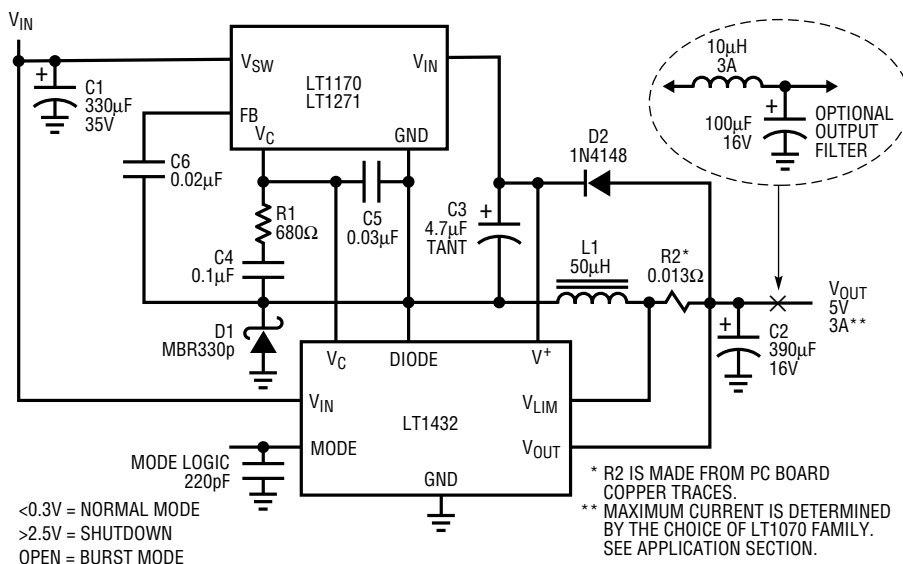
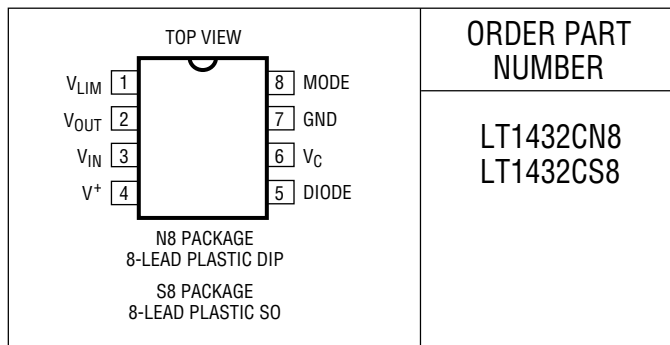

Figure 1. High Efficiency 5V Buck Converter

ABSOLUTE MAXIMUM RATINGS

V_{IN} Pin	30V
V^+ Pin	40V
V_C	35V
V_{LIM} and V_{OUT} Pins	7V
Diode Pin Voltage	30V
Mode Pin Current (Note 2)	1mA
Operating Temperature Range	0°C to 70°C
Storage Temperature Range	-65°C to 150°C
Lead Temperature (Soldering, 10 sec.)	300°C

PACKAGE/ORDER INFORMATION



ORDER PART NUMBER

LT1432CN8
LT1432CS8

ELECTRICAL CHARACTERISTICS

$V_C = 6V$, $V_{IN} = 12V$, $V^+ = 10V$, $V_{DIODE} = \text{Open}$, $V_{LIM} = V_{OUT}$, $V_{MODE} = 0V$, $T_J = 25^\circ C$
Device is in standard test loop unless otherwise noted.

PARAMETER	CONDITIONS		MIN	TYP	MAX	UNITS
Regulated Output Voltage	V_C Current = 220 μA	●	4.9	5.0	5.1	V
Output Voltage Line Regulation	$V_{IN} = 6V$ to 30V	●		5	20	mV
Input Supply Current (Note 1)	$V_{IN} = 6V$ to 30V, $V^+ = V_{IN} + 5V$, $V_C = V_{IN} + 1V$	●		0.3	0.5	mA
Quiescent Output Load Current				0.9	1.2	mA
Mode Pin Current	$V_{MODE} = 0V$ (current is out of pin) $V_{MODE} = 5V$ (shutdown)	● ●		30 15	50 30	μA μA
Mode Pin Threshold Voltage (Normal to Burst)	$I_{MODE} = 10\mu A$ (out of pin)	●	0.6	0.9	1.5	V
V_C Pin Saturation Voltage	$V_{OUT} = 5.5V$ (forced)	●		0.25	0.45	V
V_C Pin Maximum Sink Current	$V_{OUT} = 5.5V$ (forced)	●	0.45	0.8	1.5	mA
V_C Pin Source Current	$V_{OUT} = 4.5V$ (forced)	●	40	60	100	μA
Current Limit Sense Voltage (Note 3)	Device in Current Limit Loop		56	60	64	mV
V_{LIM} Pin Current	Device in Current Limit Loop (current is out of pin)	●	30	45	70	μA
Supply Current in Shutdown	$V_{MODE} > 3V$, $V_{IN} < 30V$, V_C and $V^+ = 0V$	●		15	60	μA
Burst Mode Output Ripple	Device in Burst Test Circuit			100		mV _{p-p}
Burst Mode Average Output Voltage	Device in Burst Test Circuit	●	4.8	5	5.2	V
Clamp Diode Forward Voltage	$I_F = 1mA$, All Other Pins Open	●		0.5	0.65	V
Startup Drive Current	$V_{OUT} = 2.5V$ (forced), $V^+ = 5V$ to 25V, $V_{IN} = 6V$ to 26V, $V^+ = V_{IN} - 1V$, $V_C = V_{IN} - 1.5V$	●	30	45		mA
Restart Time Delay	(Note 4)		1	1.8	10	ms
Transconductance, Output to V_C Pin	$I_C = 150\mu A$ to 250 μA	●	1500	2000	2800	μmho

The ● denotes specifications which apply over the operating temperature range.

Note 1: Does not include current drawn by the LT1070 IC. See operating parameters in standard circuit.

Note 2: Breakdown voltage on the mode pin is 7V. External current must be limited to value shown.

Note 3: Current limit sense voltage temperature coefficient is +0.33%/°C to match TC of copper trace material.

Note 4: V_{OUT} pin switched from 5.5V to 4.5V.

ELECTRICAL CHARACTERISTICS

Operating parameters in standard circuit configuration.

$V_{IN} = +12V$, $I_{OUT} = 0$, unless otherwise noted. These parameters guaranteed where indicated, but not tested.

PARAMETER	CONDITIONS	MIN	TYP	MAX	UNITS
Burst Mode Quiescent Input Supply Current			1.3	1.8	mA
Burst Mode Output Ripple Voltage	$I_{OUT} = 0$ $I_{OUT} = 50mA$		100 130		mV _{p-p} mV _{p-p}
Normal Mode Equivalent Input Supply Current	Extrapolated from $I_{OUT} = 20mA$		6		mA
Normal Mode Minimum Operating Input Voltage	$100mA < I_{OUT} < 1.5A$		6		V
Burst Mode Minimum Operating Input Voltage	$5mA < I_{OUT} < 50mA$		6.2		V
Efficiency	Normal Mode $I_{OUT} = 0.5A$ Burst Mode $I_{OUT} = 25mA$		91 77		% %
Load Regulation	Normal Mode $50mA < I_{OUT} < 2A$ Burst Mode $0 < I_{OUT} < 50mA$		10 50	25	mV mV

EQUIVALENT SCHEMATIC

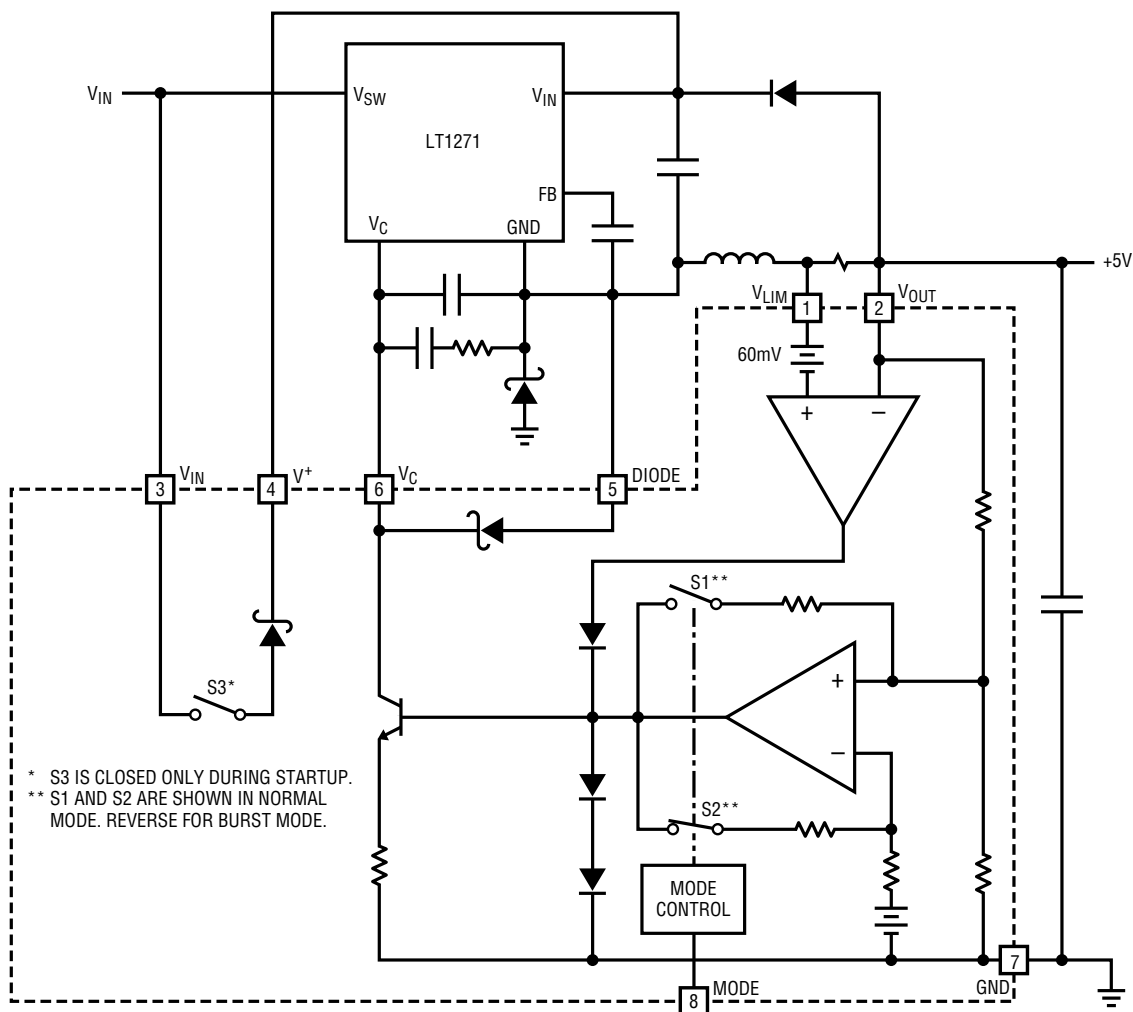
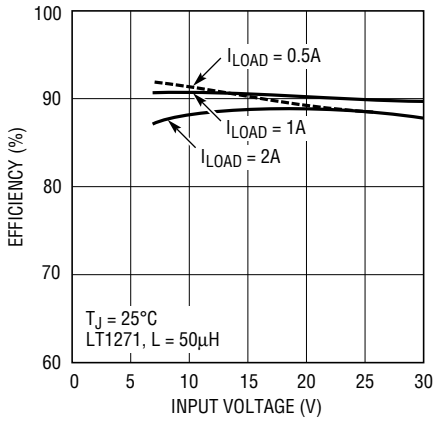

Figure 2

LT1432 F02

TYPICAL PERFORMANCE CHARACTERISTICS

Efficiency vs Input Voltage



LT1432 G01

Efficiency vs Load Current

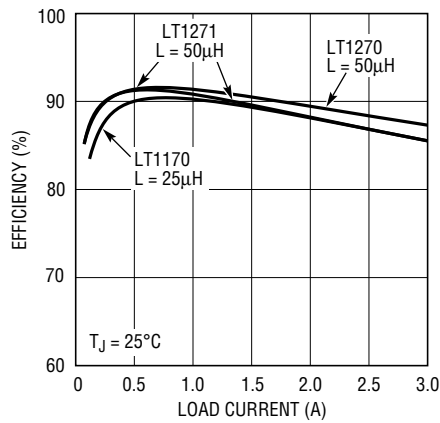

LT1432 G02

Minimum Input Voltage – Normal Mode (1270/1271)

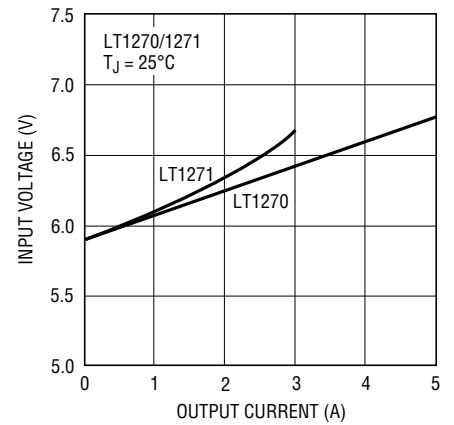

LT1432 G03

Minimum Input Voltage – Normal Mode (1070 Family)

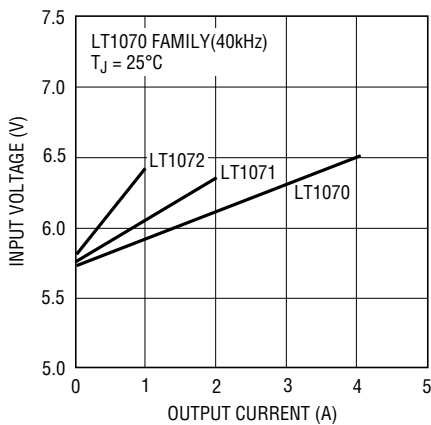

LT1432 G04

Minimum Input Voltage – Normal Mode (1170 Family)

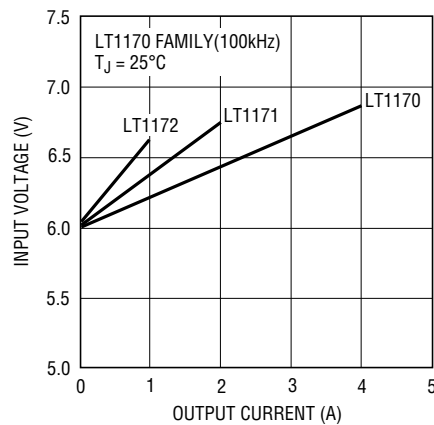

LT1432 G05

Burst Mode Minimum Input Voltage

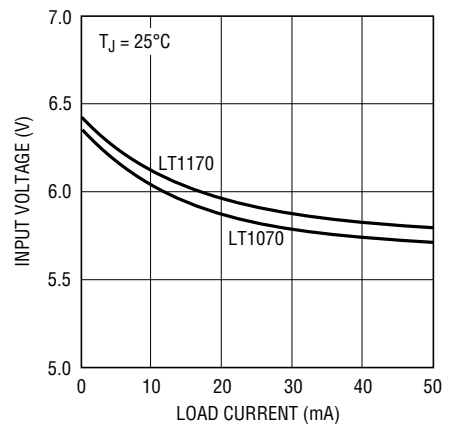

LT1432 G06

Shutdown Current vs Input Voltage

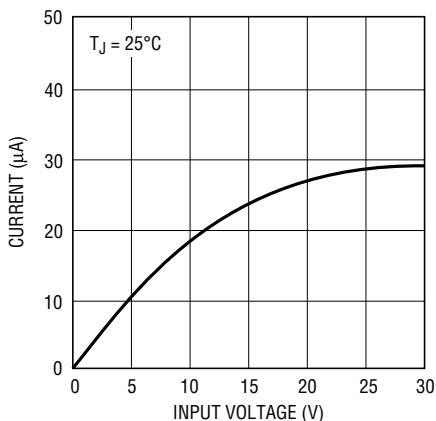

LT1432 G07

Battery Current in Shutdown*

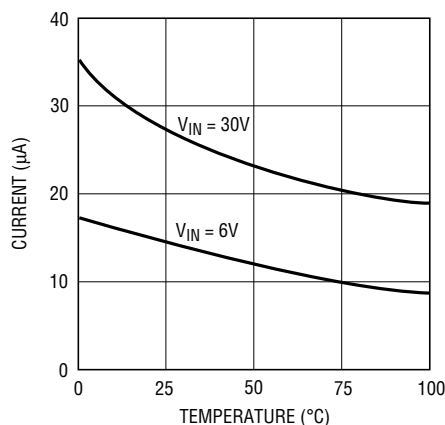

LT1432 G08

Current Limit Sense Voltage*

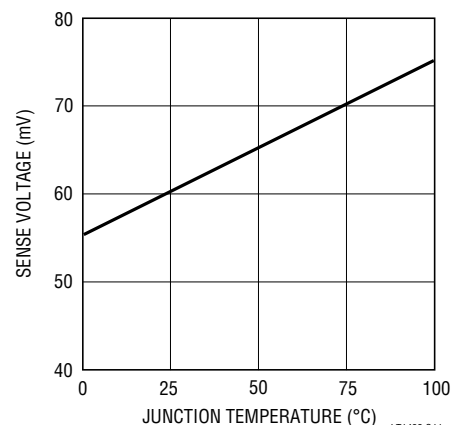

LT1432 G11

* DOES NOT INCLUDE LT1271 SWITCH LEAKAGE.

* TEMPERATURE COEFFICIENT OF SENSE VOLTAGE IS DESIGNED TO TRACK COPPER RESISTANCE.

TYPICAL PERFORMANCE CHARACTERISTICS

Incremental Battery Current * in Burst Mode

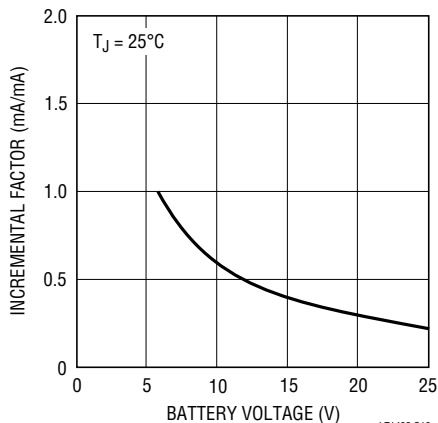

LT1432 G10

No Load Battery Current in Burst Mode

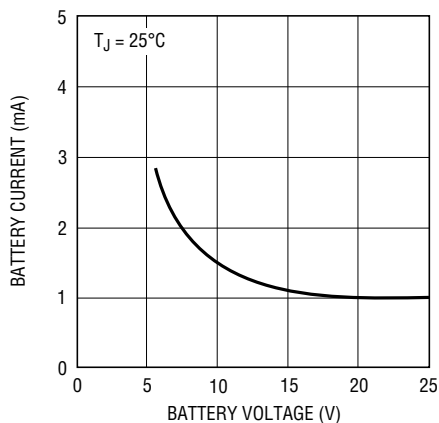

LT1432 G09

Transconductance – V_{OUT} to V_C Current

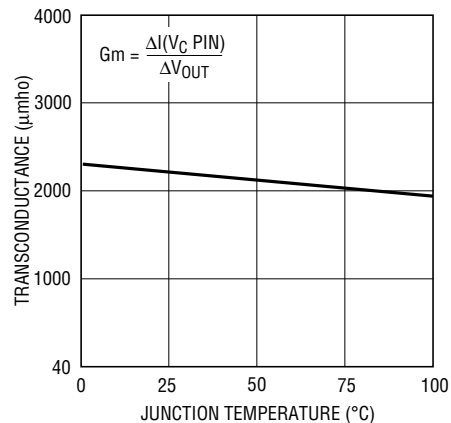

LT1432 G12

* TO CALCULATE TOTAL BATTERY CURRENT IN BURST MODE, MULTIPLY LOAD CURRENT BY INCREMENTAL FACTOR AND ADD NO-LOAD CURRENT.

Line Regulation

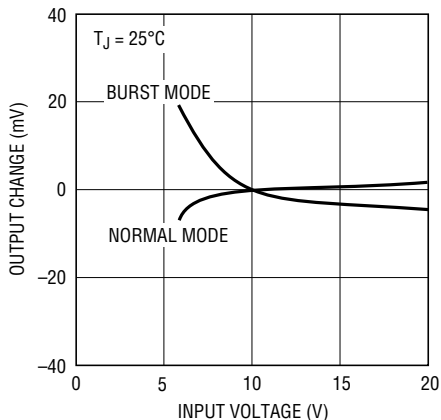

LT1432 G13

Burst Mode Load Regulation

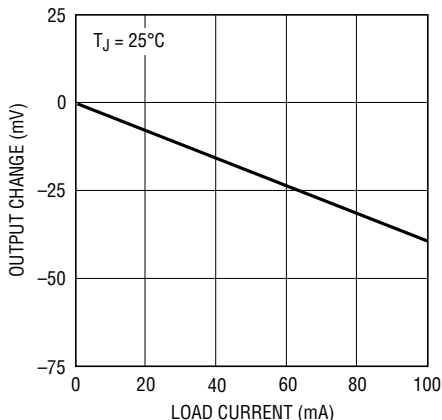

LT1432 G14

Mode Pin Current

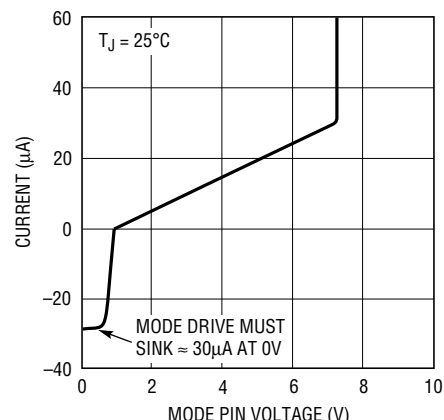

LT1432 G15

Restart Load Current

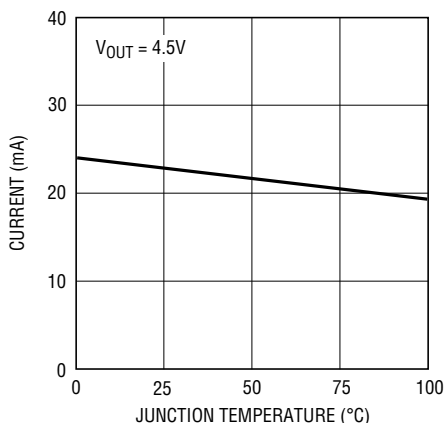

LT1432 G16

Restart Time Delay

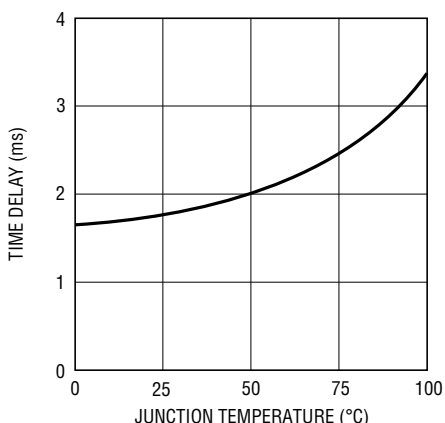

LT1432 G16

Startup Switch Characteristics

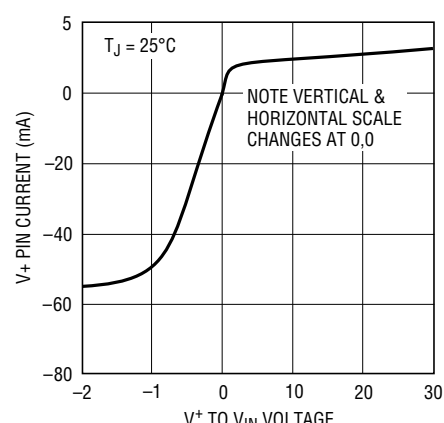

LT1432 G18

APPLICATIONS INFORMATION

Basic Circuit Description

The LT1432 is a dedicated 5V buck converter driver chip intended to be used with an IC switcher from the LT1070 family. This family of current mode switchers includes current ratings from 1.25A to 10A, and switching frequencies from 40kHz to 100kHz as shown in the table below.

DEVICE	SWITCH CURRENT	FREQUENCY	OUTPUT CURRENT IN BUCK CONVERTER
LT1270A	10A	60kHz	7.5A
LT1270	8A	60kHz	6A
LT1170	5A	100kHz	3.75A
LT1070	5A	40kHz	3.75A
LT1271	4A	60kHz	3A
LT1171	2.5A	100kHz	1.8A
LT1071	2.5A	40kHz	1.8A
LT1172	1.25A	100kHz	0.9A
LT1072	1.25A	40kHz	0.9A

The maximum load current which can be delivered by these chips in a buck converter is approximately 75% of their switch current rating. This is partly due to the fact that buck converters must operate at very high duty cycles when input voltage is low. The “current mode” nature of the LT1070 family requires an internal reduction of peak current limit at high duty cycles, so these devices are rated at only 80% of their full current rating when duty cycle is 80%. A second factor is inductor ripple current, half of which subtracts from maximum available load current. See Inductor Selection for details. The LT1070 family was originally intended for topologies which have the negative side of the switch grounded, such as boost converters. It has an extremely efficient quasi-saturating NPN switch which mimics the linear resistive nature of a MOSFET but consumes much less die area. Driver losses are kept to a minimum with a patented adaptive antisat drive that maintains a forced beta of 40 over a wide range of switch currents. This family is attractive for high efficiency buck converters because of the low switch loss, but to operate as a positive buck converter, the ground pin of the IC must be floated to act as the switch output node. This requires a floating power supply for the chip and some means for level shifting the feedback signal. The LT1432 performs these functions as well as adding current limiting, micropower shutdown, and dual mode operation for high conversion efficiency with both heavy and very light loads.

The circuit in Figure 1 is a basic 5V positive buck converter which can operate with input voltage from 6V to 30V. The power switch is located between the V_{SW} pin and GND pin on the LT1271. Its current and duty cycle are controlled by the voltage on the V_C pin with respect to the GND pin. This voltage ranges from 1V to 2V as switch current increases from zero to full scale. Correct output voltage is maintained by the LT1432 which has an internal reference and error amplifier (see Equivalent Schematic in Figure 2). The amplifier output is level shifted with an internal open collector NPN to drive the V_C pin of the switcher. The normal resistor divider feedback to the switcher feedback pin cannot be used because the feedback pin is referenced to the GND pin, which is switching up and down. The feedback pin (FB) is simply bypassed with a capacitor. This forces the switcher V_C pin to swing high with about 200 μ A sourcing capability. The LT1432 V_C pin then sinks this current to control the loop. Transconductance from the regulator output to the V_C pin current is controlled to approximately 2000 μ mhos by local feedback around the LT1432 error amplifier (S2 closed in Figure 2). This is done to simplify frequency compensation of the overall loop. A word of caution about the FB pin bypass capacitor (C6): this capacitor value is very non-critical, but the capacitor must be connected directly to the GND pin or tab of the switcher to avoid differential spikes created by fast switch currents flowing in the external PCB traces. This is also true for the frequency compensation capacitors C4 and C5. C4 forms the dominant loop pole with a loop zero added by R1. C5 forms a higher frequency loop pole to control switching ripple at the V_C pin.

A floating 5V power supply for the switcher is generated by D2 and C3 which peak detect the output voltage during switch “off” time. The diode used for D2 is a low capacitance type to avoid spikes at the output. Do not substitute a Schottky diode for D2 (they are high capacitance). This is a very efficient way of powering the switcher because power drain does not increase with regulator input voltage. However, the circuit is not self-starting, so some means must be used to start the regulator. This is performed by the internal current path of the LT1432 which allows current to flow from the input supply to the V^+ pin during startup.

APPLICATIONS INFORMATION

D1, L1 and C2 act as the conventional catch diode and output filter of the buck converter. These components should be selected carefully to maintain high efficiency and acceptable output ripple. See other sections of this data sheet for detailed discussions of these parts.

Current limiting is performed by R2. Sense voltage is only 60mV to maintain high efficiency. This also reduces the value of the sense resistor enough to utilize a printed circuit board trace as the sense resistor. The sense voltage has a positive temperature coefficient of 0.33%/°C to match the temperature coefficient of copper. See Current Limiting section for details.

The basic regulator has three different operating modes, defined by the mode pin drive. Normal operation occurs when the mode pin is grounded. A low quiescent current “burst” mode can be initiated by floating the mode pin. Input supply current is typically 1.3mA in this mode, and output ripple voltage is 100mV_{p-p}. Pulling the mode pin above 2.5V forces the entire regulator into micropower shutdown where it typically draws less than 20µA. See Mode Pin Drive for details.

Efficiency

Efficiency in normal mode is maximum at about 500mA load current, where it exceeds 90%. At lower currents, the operating supply current of the switching IC dominates losses. The power loss due to this term is approximately 8mA × 5V, or 40mW. This is 4% of output power at a load current of 200mA. At higher load currents, losses in the switch, diode, and inductor series resistance begin to increase as the square of current and quickly become the dominant loss terms.

Loss in inductor series resistance;

$$P = R_S (I_{OUT})^2$$

Loss in switch on resistance;

$$P = \frac{V_{OUT}(R_{SW})(I_{OUT})^2}{V_{IN}}$$

Loss in switch driver current;

$$P = \frac{I_{OUT}(V_{OUT})^2}{40V_{IN}}$$

Diode loss;

$$P = \frac{V_F(V_{IN} - V_{OUT})(I_{OUT})}{V_{IN}}$$

(Use V_F vs I_F graph on diode data sheet, assuming $I_F = I_{OUT}$)

R_S = Inductor series resistance

R_{SW} = Switch resistance of LT1271, etc.

I_F = Diode current

V_F = Diode forward voltage at $I_F = I_{OUT}$

Inductor core loss depends on peak-to-peak ripple current in the inductor, which is independent of load current for any load current large enough to establish continuous current in the inductor. Believe it or not, core loss is also independent of the physical size of the core. It depends only on core material, inductance value, and switching frequency for fixed regulator operating conditions. Increasing inductance or switching frequency will reduce core loss, because of the resultant decrease in ripple current. For high efficiency, low loss cores such as ferrites or Magnetics Inc. molypermalloy or KoolMµ are recommended. The lower cost Type 52 powdered iron from Phillips is acceptable only if larger inductance is used and the increased size and slight loss in efficiency is acceptable. In a typical buck converter using the LT1271 (60kHz) with a 12V input, and a 50µH inductor, core loss with a Type 52 powdered iron core is 203mW. A molypermalloy core reduces this figure to 28mW. With a 1A output, this translates to 4% and 0.56% core loss respectively – a big difference in a high efficiency converter. For details on inductor design and losses, see Application Note 44.

What are the benefits of using an active (synchronous) switch to replace the catch diode? This is the trendy thing to do, but calculations and actual breadboards show that the improvement in efficiency is only a few percent at best. This can be shown with the following simplified formulas:

$$\text{Diode Loss} = \frac{V_F(V_{IN} - V_{OUT})(I_{OUT})}{V_{IN}}$$

APPLICATIONS INFORMATION

$$\text{FET Switch Loss} = \frac{(V_{\text{IN}} - V_{\text{OUT}})(R_{\text{SW}})(I_{\text{OUT}})^2}{V_{\text{IN}}}$$

(Ignoring gate drive power)

The change in efficiency is:

$$\frac{(\text{Diode Loss} - \text{FET Loss})(\text{Efficiency})^2}{(V_{\text{IN}})(V_{\text{OUT}})}$$

This is equal to:

$$\frac{(V_{\text{IN}} - V_{\text{OUT}})(V_{\text{F}} - R_{\text{FET}} \times I_{\text{OUT}})(E)^2}{(V_{\text{IN}})(V_{\text{OUT}})}$$

If V_{F} (diode forward voltage) = 0.45V, $V_{\text{IN}} = 10\text{V}$, $V_{\text{OUT}} = 5\text{V}$, $R_{\text{FET}} = 0.1\Omega$, $I_{\text{OUT}} = 1\text{A}$, and efficiency = 90%, the improvement in efficiency is only:

$$\frac{(10\text{V} - 5\text{V})(0.45\text{V} - 0.1\Omega \times 1\text{A})(0.9)^2}{(10\text{V})(5\text{V})} = 2.8\%$$

This does not take FET gate drive losses into account, which can easily reduce this figure to less than 2%. The added cost, size, and complexity of a synchronous switch configuration would be warranted only in the most extreme circumstances.

Burst mode efficiency is limited by quiescent current drain in the LT1432 and the switching IC. The typical burst mode zero-load input power is 27mW. This gives about one month battery life for a 12V, 1.2Ahr battery pack. Increasing load power reduces discharge time proportionately. Full shutdown current is only about 15μA, which is considerably less than the self-discharge rate of typical batteries.

Burst Mode Operation

Burst mode is initiated by allowing the mode pin to float, where it will assume a DC voltage of approximately 1V. If AC pickup from surrounding logic lines is likely, the mode pin should be bypassed with a 200pF capacitor. Burst mode is used to reduce quiescent operating current when the regulator output current is very low, as in “sleep” mode

in a lap-top computer. In this mode, hysteresis is added to the error amplifier to make it switch on and off, rather than maintain a constant amplifier output. This forces the switching IC to either provide a rapidly increasing current or to go into full micropower shutdown. Current is delivered to the output capacitor in pulses of higher amplitude and low duty cycle rather than a continuous stream of low amplitude pulses. This maximizes efficiency at light load by eliminating quiescent current in the switching IC during the period between bursts.

The result of pulsating currents into the output capacitor is that output ripple amplitude increases, and ripple frequency becomes a function of load current. The typical output ripple in burst mode is 150mVp-p, and ripple frequency can vary from 50Hz to 2kHz. This is not normally a problem for the logic circuits which are kept “alive” during sleep mode.

Some thought must be given to proper sequencing between normal mode and burst mode. A heavy (>100mA) load in burst mode can cause excessive output ripple, and an abnormally light load (10mA to 30mA, see curves) in normal mode can cause the regulator to revert to a quasi-burst mode that also has higher output ripple. The worst condition is a sudden, large increase in load current (>100mA) during this quasi-burst mode or just after a switch from burst mode to normal mode. This can cause the output to sag badly while the regulator is establishing normal mode operation ($\approx 100\mu\text{s}$). To avoid problems, it is suggested that the power-down sequence consist of reducing load current to below 100mA, but greater than the minimum for normal mode, then switching to burst mode, followed by a reduction of load current to the final sleep value. Power-up would consist of increasing the load current to the minimum for normal mode, then switching to normal mode, pausing for 1ms, followed by return to full load.

If this sequence is not possible, an alternative is to minimize normal mode settling time by adding a 47kΩ resistor between V^+ and V_{C} pins. The output capacitor should be increased to >680μF and the compensation capacitors should also be as small as possible, consistent with adequate phase margin. These modifications will

APPLICATIONS INFORMATION

often allow the power-down sequence to consist of simultaneous turn-off of load current and switch to burst mode. Power-up is accomplished by switching to normal mode and simultaneously increasing load current to the lowest possible value (30mA to 500mA), followed by a short pause and return to full load current.

Full Shutdown

When the mode pin is driven high, full shutdown of the regulator occurs. Regulator input current will then consist of the LT1432 shutdown current ($\approx 15\mu\text{A}$) plus the switch leakage of the switching IC ($\approx 1\mu\text{A}$ to $25\mu\text{A}$). Mode input current ($\approx 15\mu\text{A}$ at 5V) must also be considered. Startup from shutdown can be in either normal or burst mode, but one should always check startup overshoot, especially if the output capacitor or frequency compensation components have been changed.

Switching Waveforms in Normal Mode

The waveforms in Figures 3 through 10 were taken with an input voltage of 12V. Figure 3 shows the classic buck converter waveforms of switch output voltage (5V/DIV) at the top and switch current (1A/DIV) underneath, at an output current of 2A. The regulator is operating in “continuous” mode as evidenced by the fact that switch current does not start at zero at switch turn-on. Instead, it jumps to an initial value, then continues to slope upward during the duration of switch on time. The slope of the current waveform is determined by the difference between input and output voltage, and the value of inductor used.

$$\frac{dI}{dt} = \frac{(V_{IN} - V_{OUT})}{L}$$

According to theory, the average switch current during switch on time should be equal to the 2A output current and this is confirmed in the photograph. The peak switch current, however, is about 2.4A. This peak current must be considered when calculating maximum available load current because both the LT1432 and the LT1070 family current limit on instantaneous switch current.

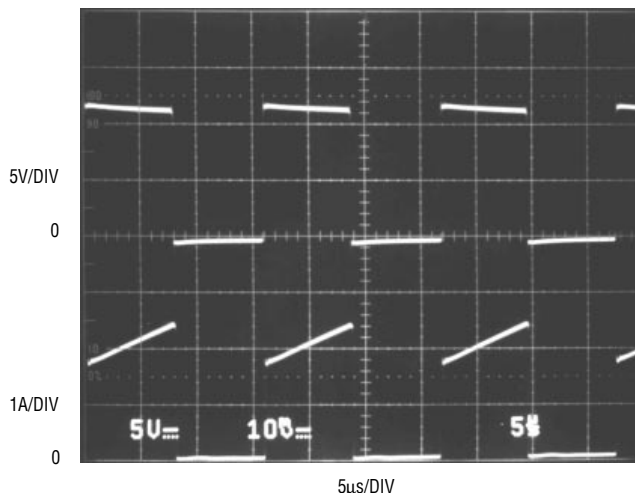

Figure 3

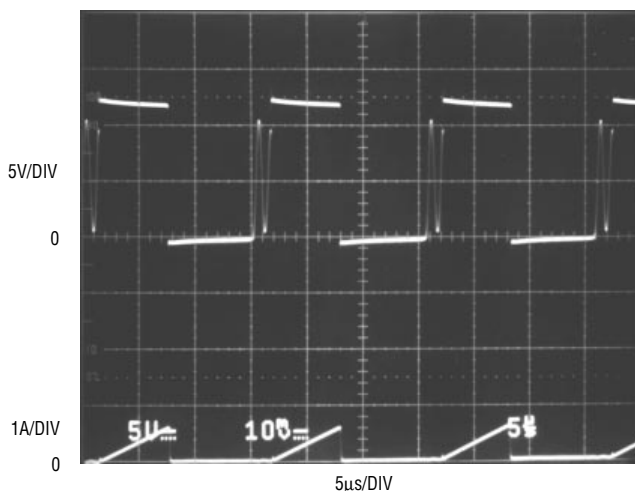

Figure 4

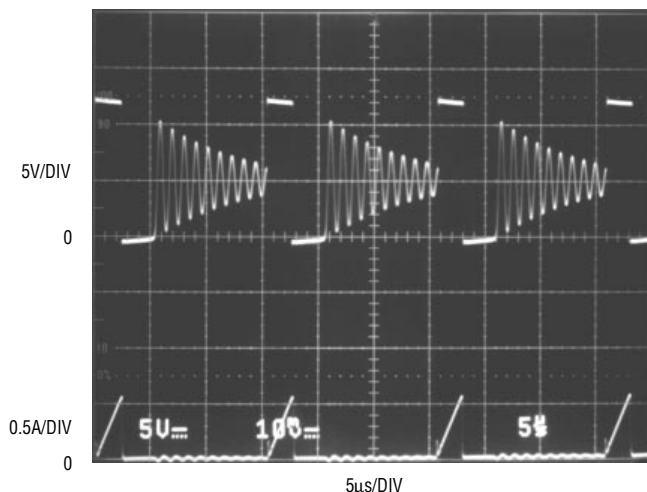

Figure 5

APPLICATIONS INFORMATION

Note that the switch output voltage is nearly identical to the 12V input during switch on time, a necessary requirement for high efficiency, and indicative of an efficient switch topology. Also note the fast, clean edges on the switching waveforms, an additional requirement for high efficiency. The “overlap time” of switch current and voltage, which leads to AC switching losses, is only 10ns.

Figure 4 shows the same waveforms when load current has been reduced to 0.25A, and Figure 5 is at 25mA (note the scale change for current in Figure 5). The regulator is now into discontinuous mode as shown by the fact that switch current has no initial jump, but starts its upward slope from zero. This implies that the inductor current has dropped to zero during switch off time, and that is shown by the “ringing” waveform on the rising edge of switch voltage. The switch has not yet been turned on, but the voltage at its output rises and rings as the “input” end of the inductor tries to settle to the same voltage as its “output” end (5V).

This ringing is not an oscillation. It is the result of stored energy in the catch diode capacitance. This energy is transferred to the inductor as the inductor voltage attempts to rise to 5V. The inductor and diode capacitance tank circuit continues to ring until the stored energy is dissipated by losses in the core and parasitic resistances. The relatively undamped nature in this case is good because it shows low losses and that translates to high efficiency. EMI is not increased by operating in this mode.

Figure 6 shows input capacitor current (1A/DIV) with $I_{OUT} = 2A$. The theoretical peak-to-peak value (ignoring sloping waveforms) is equal to output current, and this is indeed what the top waveform shows. The RMS value is approximately equal to one half output current. This is a major consideration because the physical size of a capacitor with 1A ripple current rating may make it the largest component in the regulator (see output capacitor section). Clever designers may hit on the idea of utilizing battery impedance or remote input capacitors to divert some of the current away from the actual local capacitor to reduce its size. This is not too practical as shown by the middle waveform in Figure 6, which shows input capacitor current when an additional large capacitor is added about 6" away from the

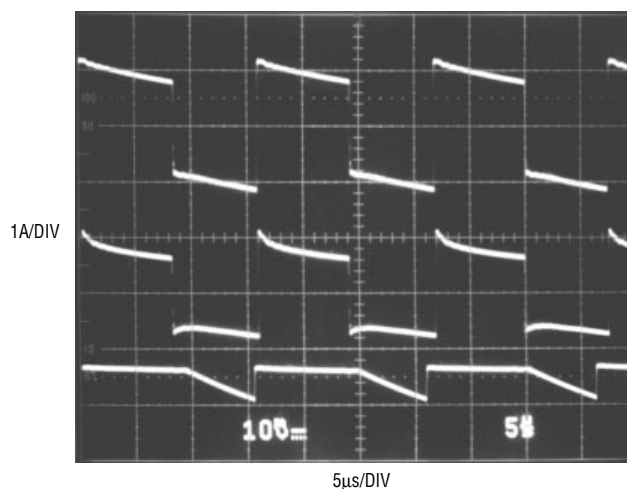

Figure 6. Input Capacitor Current

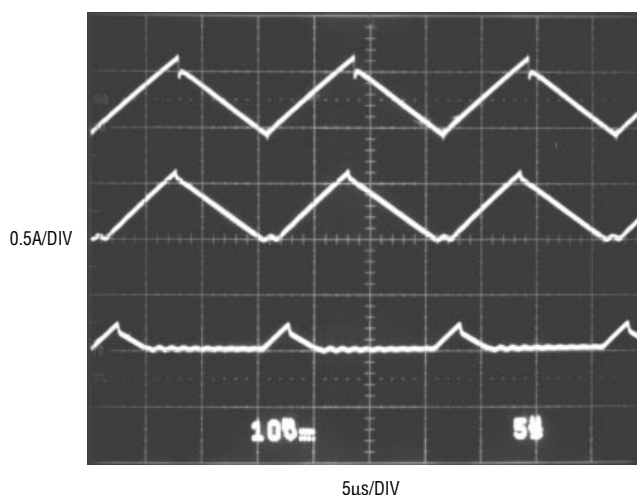

Figure 7. Output Capacitor Ripple Current

local capacitor. The wiring inductance and parasitic resistance limit the shunting effect and local capacitor current is reduced only slightly. The bottom waveform shows input capacitor current with output current reduced to 0.25A.

Figure 7 shows output capacitor ripple current at loads of 2A, 0.25A, and 25mA respectively starting from the top. Note that ripple current is independent of load current until the load drops well into the discontinuous region. The small steps superimposed on the triangular ripple are caused by loading of the diode which pumps the power supply capacitor on the LT1271. Amplitude of the ripple current is about 0.7Ap-p in this case, or approximately

APPLICATIONS INFORMATION

0.2A RMS. Theoretically the output capacitor size would be minimized by using one which just met this ripple current, but in practice, this would yield such high output ripple voltage that an additional output filter would have to be added. A better solution in the case of buck converters is usually just to increase the size of the output capacitor to meet output ripple voltage requirements.

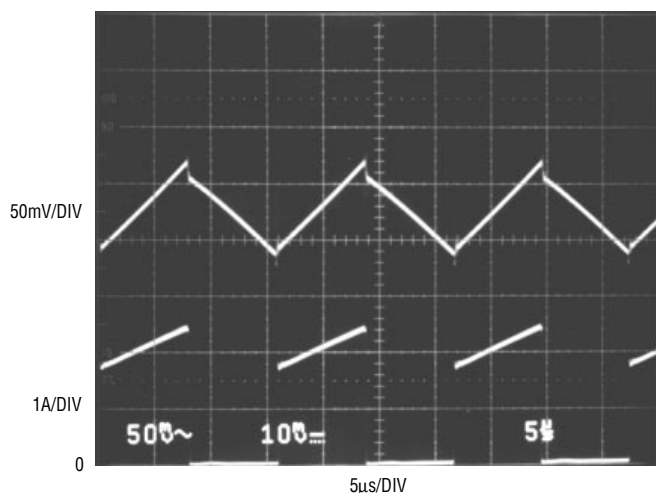

Figure 8. Output Ripple Current

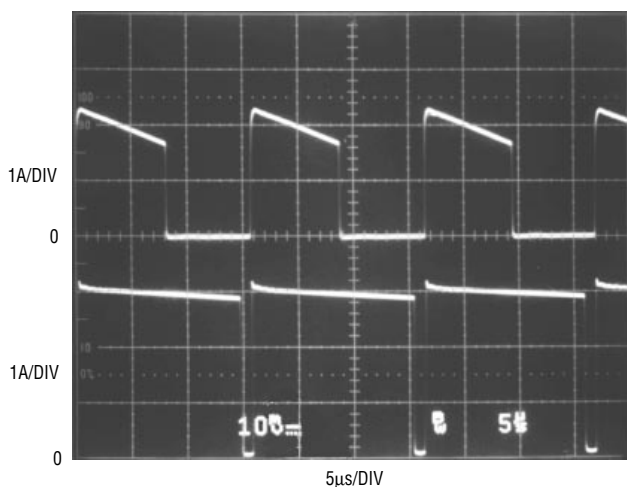

Figure 9. Diode Current

Figure 8 shows output ripple voltage at the top and switch current below. Peak-to-peak ripple voltage is 80mV. This implies an output capacitor effective series resistance (ESR) of $80\text{mV}/0.7\text{A} = 0.11\Omega$. Capacitor ESR varies significantly with temperature, increasing at low tempera-

tures, so be sure to check ESR ratings at the lowest expected operating temperature. Ripple voltage can be reduced by increasing the inductor value, but this has rapidly diminishing returns because of typical size restraints.

Figure 9 shows diode current under normal load conditions of 2A, and with the output shorted. Current limit has been set at 3A. Average diode current at $I_{OUT} = 2\text{A}$ is only about 1A because of duty cycle considerations. Under short circuit conditions, duty cycle is nearly 100% for the diode (switch duty cycle is near zero), and diode average current is nearly 3A. Designs which must tolerate continuous short circuit conditions should be checked carefully for diode heating. Foldback current limiting can be used if necessary.

Figure 10 shows inductor current (0.5A/DIV) with a 2A and 100mA load. Average inductor current is always equal to output current, but it is obvious that with 100mA load, inductor current drops to zero for part of the switching cycle, indicating discontinuous mode. When selecting an inductor, keep in mind that RMS current determines copper losses, peak-to-peak current determines core loss, and peak current must be calculated to avoid core saturation. Also, remember that during short circuit conditions, inductor current will increase to the full current limit value. Inductor failure is normally caused by overheating of the winding insulation with resultant turn-to-turn shorts. Foldback current limiting will be helpful.

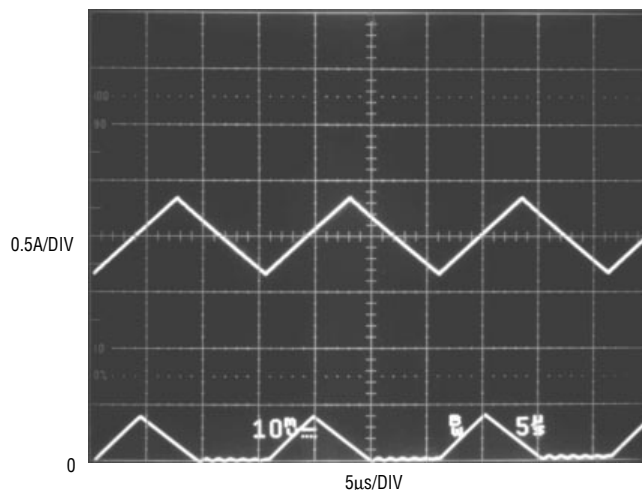

Figure 10. Inductor Current

APPLICATIONS INFORMATION

Switching Waveforms in Burst Mode

In burst mode, the LT1432 amplifier is converted to a comparator with hysteresis. This causes its V_C pin current drive to be either zero (output low), or full “on” at about 0.8mA (output high). The LT1271 therefore is either driven to full on condition or forced into complete micropower shutdown. This makes a dramatic reduction in quiescent current losses because the switching regulator chip draws supply current only during the relatively short “on” periods. This burst mode results in a battery drain of only 1.2mA with zero output load, even though the nominal quiescent current of the switcher chip is 7mA. This low battery drain is accomplished at the expense of higher output ripple voltage, but the ripple is still well within the normal requirements for logic chips.

Figure 11 shows burst mode output ripple at load currents of 0 (top trace), and 50mA (bottom trace). Ripple amplitude is nominally set by the 100mV hysteresis built into the LT1432, but in most applications, other effects come into play which can significantly modify this value. The first is delay in turning off the switcher. This causes the output to overshoot slightly and therefore increases output ripple. Delay is caused by the compensation capacitors used to maintain a stable loop in the normal mode. Another effect, however, is the ESR of the output capacitor. The surge current from the switcher creates a step across the capacitor ESR which prematurely trips the LT1432 comparator, *reducing* ripple amplitude. A second delay occurs in turning the switcher back on when the output falls below its lower level. This delay is somewhat longer, but because the output normally falls at a much slower rate than it rises, this delay is not significant until output current exceeds 10mA. Falling rate is set by the output capacitor (including any secondary filter capacitor), and the actual load current, $dV_{OUT}/dt = I_{OUT}/C_{OUT}$. The slope in the top traces implies a load current of approximately 2mA. This is the sum of the 1mA output quiescent current of the LT1432 and the 1mA drawn by the V_C pin and shunted through the internal Schottky diode during the switcher “off” period.

The bottom trace at $I_{OUT} = 50mA$ shows increased ripple caused by turn-on delay. Note that ripple frequency has increased from 50Hz to about 600Hz and amplitude has

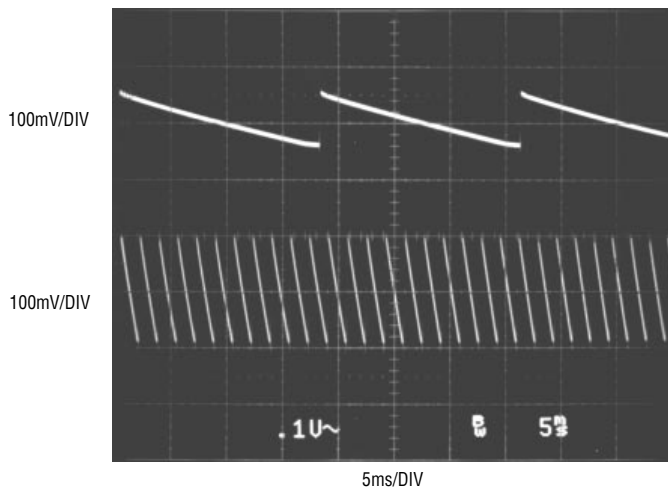

Figure 11. Burst Mode Output Ripple Voltage

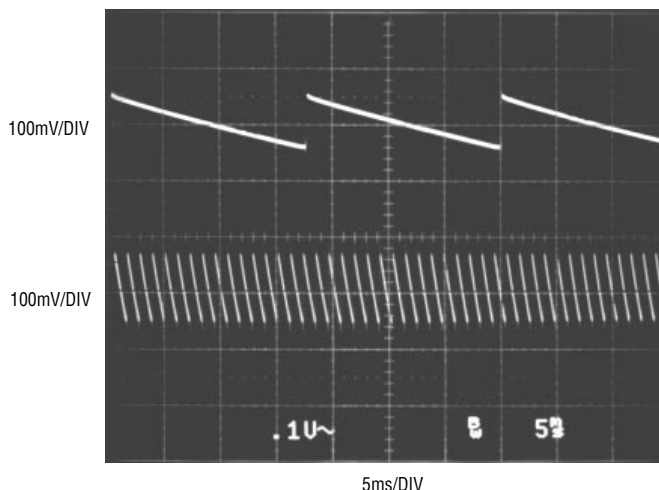

Figure 12. Burst Mode Output Ripple Voltage

more than doubled. Figure 12 shows the same conditions except that a 47kΩ resistor is connected from the LT1271 V_{IN} pin to the V_C pin to provide more start-up current. These additions reduce ripple amplitude at 50mA load current to a value only slightly higher than the no-load condition.

Although it is difficult to see in Figures 11 and 12, there is a narrow spike on the leading edge of the ripple caused by the burst current and capacitor ESR. Figure 13 shows this spike in more detail, both with and without an output filter.

APPLICATIONS INFORMATION

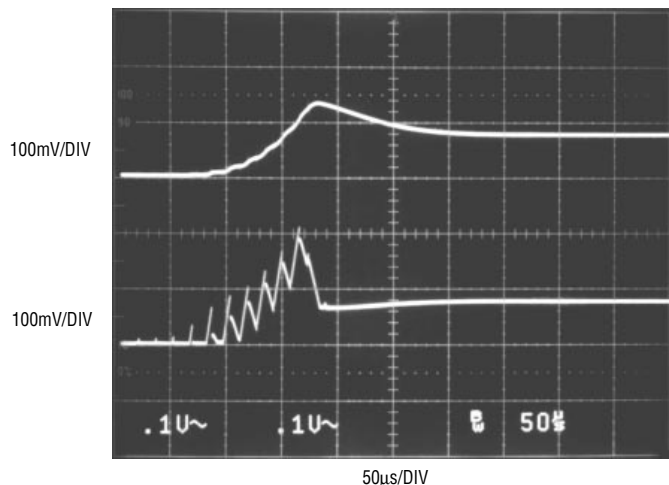

Figure 13

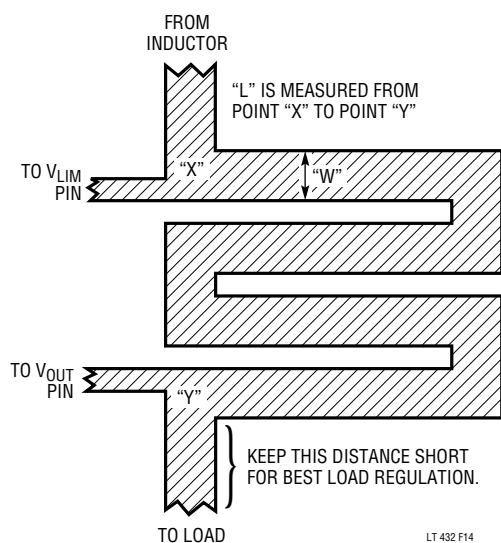

Figure 14. PC trace Current Limit Sense Resistor with Kelvin Contacts

Time scale has been expanded to 50µs/DIV. The spike consists of several switching cycles of the LT1271 as shown in the lower trace. In the upper trace, the output filter has smoothed the switching frequency content of the spike, but the actual spike amplitude is only modestly reduced. Increasing the output filter constants from 10µH and 220µF to 20µH and 330µF would eliminate most of the spike.

Current Limiting

The LT1432 has true switching current limit with a sense voltage of 60mV. This low sense voltage is used to maintain high efficiency with normal loads and to make it possible to use the printed circuit board trace material as the sense resistor. The sense resistor value must take ripple current into account because the LT1432 limits on the peak of the inductor ripple current. Errors in the sense resistor must also be allowed for.

$$R_{SENSE} = \frac{V_{SENSE}}{I_{MAX}(1.2)^* + \frac{I_{RIP}}{2}}$$

R_{SENSE} = Required sense resistor

V_{SENSE} = 60mV

I_{MAX} = Maximum load current, including any surge longer than 50µs

* 1.2 is a fudge factor for errors in R_{SENSE} and V_{SENSE} .

$$\begin{aligned} \frac{I_{RIP}}{2} &= 1/2 \text{ Peak to Peak Inductor Ripple Current} \\ &= \frac{V_{OUT}(V_{IN} - V_{OUT})}{2V_{IN}(f)(L)} \end{aligned}$$

f = Frequency

L = Inductance

Use V_{IN} maximum

Example: $I_{MAX} = 2A$, $f = 60kHz$, maximum $V_{IN} = 15V$, $L = 50\mu H$;

$$\frac{I_{RIP}}{2} = \frac{5(15 - 5)}{2(15)(60E^3)(50E^{-6})} = 0.55A$$

$$R_{SENSE} = \frac{60mV}{2A(1.2) + 0.55A} = 0.02\Omega$$

The formula for R_{SENSE} shows a 1.2 multiplier term in the denominator which makes typical current limit 20% above full load current. This accounts for small errors in the PCB trace resistance. Trace resistance errors are kept to a minimum by using internal traces (on multilayer boards)

APPLICATIONS INFORMATION

because these traces do not have errors caused by plating operations. The suggested trace width for 1/2oz foil is 0.03" for each 1A of current limit to keep trace temperature rise reasonable. 3A current limit would require the width to be 0.09". 1oz foil can reduce trace width to 0.02" per amp. Inductance in the trace is not critical so the trace can be wound serpentine or any other shape that fits available space. Kelvin connections should be used as shown in Figure 14 to avoid errors due to termination resistance.

The length of the sense resistor trace can be calculated from:

$$\text{Length} = \frac{W(R_{\text{SENSE}})}{R_{\text{CU}}} \text{ Inches}$$

W = width of copper trace (≈ 0.03 " per amp for 1/2oz copper foil)

R_{CU} = resistivity of PCB trace, expressed as Ω per square. It is found by calculating the resistance of a section of trace with equal length and width. For typical 1/2oz material, R_{CU} is approximately 1m Ω per square. In the example shown above, with width = 2A times 0.03" = 0.06";

$$\text{Length} = \frac{0.06(0.02)}{0.001} = 1.2 \text{ Inches}$$

Current limiting maintains true switching action, but power dissipation in the IC switch and catch diode will shift depending on output voltage. At output voltages near the correct regulated value, power will be distributed between switch and the diode according to the usual calculations. Under short circuit conditions, switch duty cycle will drop to a very low value, and power will concentrate in the diode, which will be running at near 100% duty cycle. If continuous shorts must be tolerated, the catch diode must be sized to handle the full current limit value, or foldback current can be used.

Foldback Current Limiting

Foldback current limiting makes the short circuit current limit somewhat lower than the full load current limit to reduce component stress under short circuit conditions. This is shown in Figure 15 with the addition of R3 and R4. The voltage drop across R3 adds to the 60mV current limit

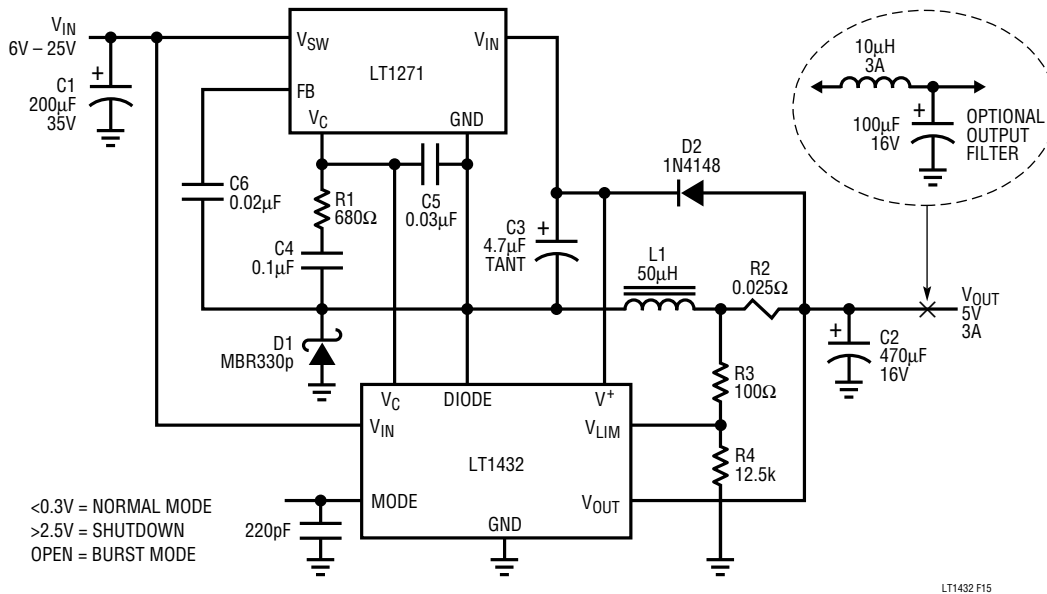

Figure 15. Adding Foldback Current Limiting

APPLICATIONS INFORMATION

voltage. This extra sense voltage is set by output voltage and R4 under normal loads, but drops to near zero when the output is shorted.

The 40μA bias current flowing out of the V_{LIM} pin must be accounted for when calculating a value for R4. This current flows through R3, causing a 4mV decrease in sense voltage for R3 = 100Ω. The following formulas define current limit conditions:

Current limit at V_{OUT} = 5V

$$= \frac{60\text{mV} - I_B(R3) + (V_{\text{OUT}})\left(\frac{R3}{R4}\right) - (R_{\text{SENSE}})\left(\frac{I_{\text{RIP}}}{2}\right)}{R_{\text{SENSE}}}$$

$$\text{Short Circuit Current} = \frac{60\text{mV} - I_B(R3)}{R_{\text{SENSE}}}$$

$$R_{\text{SENSE}} = \frac{V_{\text{LIM}}}{I_{\text{MAX}}(1.2)}$$

$$R4 = \frac{V_{\text{OUT}}(R3)}{V_S - 60\text{mV} + I_B(R3) + (R_{\text{SENSE}})\left(\frac{I_{\text{RIP}}}{2}\right)}$$

V_S = Desired full load sense voltage.

I_{MAX} = Peak load current (for any time greater than 50μs)

I_B = V_{LIM} pin bias current (≈40mA)

To maintain high efficiency and avoid any startup problems with loads that have non-linear V/I characteristics, a 100mV (average) sense voltage is suggested for foldback current limiting. The suggested value for R3 is 100Ω. This is a compromise value to keep errors due to V_{LIM} bias current low, and to minimize current drain on the output created by the R3/R4 path. From the previous design example, with I_{MAX} = 2A and I_{RIP}/2 = 0.55A, and assuming R3 = 100Ω, V_{LIM} = 100mV:

$$R_{\text{SENSE}} = \frac{100\text{mV}}{2\text{A}(1.2)} = 0.042\Omega$$

$$R4 = \frac{5V(100\Omega)}{100\text{mV} - 60\text{mV} + 100\Omega(40\mu\text{A}) - 0.042(0.55)}$$

$$= 7.45\text{k}\Omega$$

Current limit at V_{OUT} = 5V

$$= \frac{60\text{mV} - 40\mu\text{A}(100\Omega) + 5V\left(\frac{100}{7.45\text{k}}\right)(0.042)(0.55)}{0.042\Omega}$$

$$= 2.38\text{A}$$

Current limit (output shorted)

$$= \frac{60\text{mV} - 100\Omega(40\mu\text{A})}{0.042\Omega} = 1.33\text{A}$$

Minimum Input Voltage

Minimum input voltage for a buck converter using the LT1432 is actually limited by the IC switcher used with it. There are three factors which contribute to the minimum voltage. At very light loads, the charge pump technique used to provide the floating power for the switcher chip is unable to provide sufficient current. See Figure 16 for the minimum load required as a function of input voltage when operating in the normal mode.

At moderate to heavy loads, switch on-resistance and maximum duty cycle will limit minimum input voltage. Graphs in the Typical Performance Characteristics section show minimum input voltage as a function of load current. At moderate loads, maximum switch duty cycle is the limiting factor. The LT1070 family, operating at 40kHz has a maximum duty cycle of about 94%. The LT1170 family runs at 100kHz and has a maximum duty cycle of 90%. The LT1270 and LT1271 operate at 60kHz with a maximum duty cycle of 92%. The curves were generated using the expected worst case duty cycle for these devices over the commercial operating temperature range (0°C to 100°C junction temperature). Note that the lower frequency devices will operate at lower input voltage because of their higher duty cycle. These devices will require larger inductors, however. (Yet another example of the universal “no free lunch” syndrome).

APPLICATIONS INFORMATION

At heavy loads, switch on-resistance increases minimum input voltage. With an LT1071 for instance, minimum input is 6.1V at 1A load, but increases to 6.3V at 2A load. If absolute minimum input voltage is needed, use lower frequency devices with higher current rating than is actually needed. The LT1070, for instance, operates down to 6.15V at 2A. Current limit is defined by the LT1432, so higher current switchers used in lower current applications do not degrade performance or reliability.

Minimum Load Current in Normal Mode

There is a minimum load current requirement in normal mode. This is caused by the necessity to “pump” the IC switcher floating power supply capacitor during switch “off” time. This pumping current comes from inductor current, so load current must not be allowed to drop too low, or the floating bias supply for the switcher will collapse. Minimum load current is a function of input voltage as shown in Figure 16.

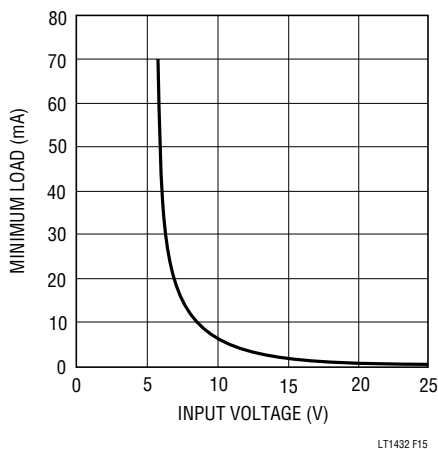

Figure 16. Minimum Normal Mode Load Current

Inductor Selection

Inductor selection would be easy if money and space didn’t count. Unfortunately, these two factors usually count the most, and compromises must be made. High efficiency converters generally cannot afford the core loss found in low cost powdered iron cores, forcing the use of more expensive cores such as ferrite, molypermalloy, or KoolM μ . Actual core loss is independent of core size for a fixed inductor value, but it is very dependent on inductance

selected. As inductance increases, core loss goes down. Unfortunately, increased inductance requires more turns of wire and therefore copper loss will increase. The trick is to find the smallest inductor whose inductance is high enough to limit core loss, and whose series resistance is low enough to limit copper loss. Historically, inductor manufacturers have a tendency to be ultra conservative when designing inductors, and unless you are very specific about your constraints and requirements, they will more often than not come up with a unit which is 50% larger than the optimum. Part of this is due to manufacturing considerations. The trade-off of core loss and copper loss is optimized by “filling the winding window” with wire, but especially for toroids this can require more expensive winding techniques than the widely used “single layer” design. The lesson here is to spend time with the manufacturer exploring the cost trade-offs of different inductor designs. The following guidelines may be helpful in this regard.

1. For most buck converter applications using the LT1070, LT1170, or LT1270 families of parts at 40kHz to 100kHz, inductor value will be in the range of 25 μ H to 200 μ H. The lower values would be used for higher output currents and/or higher frequencies, with higher values used for low output current, low frequency applications. Lower inductance obviously means smaller size, but at some point the core loss will begin to hurt, or the large peak-to-peak inductor currents will cause high output ripple voltage or limit available output current. The following formula is a rough guide for picking an initial inductor value:

$$L = \frac{8}{(I_{MAX})(f)}$$

I_{MAX} = maximum load current, including surges
 f = switching frequency

This formula assumes that a switcher IC is selected which has a maximum switch current of 1.5 to 2.5 times maximum load current. For a 2.5A design using the LT1271 at 60kHz, L would calculate to 53 μ H. This formula is very arbitrary, so do not hesitate to modify the calculated value by as much as 2:1 if the need arises. Keep in mind that all the IC switchers have a peak current rating which is a

APPLICATIONS INFORMATION

function of duty cycle. Care must be taken to ensure that the sum of output current plus 1/2 inductor p-p ripple current does not exceed the switch current limit at the highest duty cycle (lowest input voltage).

$$\text{Duty Cycle (maximum)} = \frac{V_{OUT} + V_f}{V_{IN(MIN)}}$$

V_f = Diode forward voltage

$$\text{1/2 p-p Ripple Current} = \frac{(V_{OUT})(V_{IN} - V_{OUT})}{2(V_{IN})(f)(L)}$$

(Use minimum $V_{IN} + 2V$)

A 2.5A design using an LT1271 at 60kHz, with a minimum input voltage of 7V and a 50 μ H inductor, would have a maximum duty cycle of $(5 + 0.5)/7 = 79\%$. 1/2 p-p ripple current would be:

$$\frac{(5)(7 + 2 - 5)}{2(7 + 2)(60E^3)(50E^{-6})} = 0.37A$$

Output current plus 1/2 ripple current = $2.5 + 0.37 = 2.9A$. The switch current rating for the LT1271 is shown on the data sheet as 4A for duty cycle below 50% and 2.67 (2-DC) for duty cycles greater than 50%. With DC = 79%, switch current rating would be $2.67(2 - 0.79) = 3.23A$, so this meets the guidelines. It should be noted that if normal running load current conditions result in switch currents that are close to the maximum switch ratings, efficiency will drop. Switch voltage loss at maximum switch current rating is typically 0.7V, and this represents a significant loss, especially at low input voltages. In most laptop computer designs, surge currents from hard or floppy disks require an oversized switcher, so normal running currents are typically less than one half rated switch current and efficiency is high except during the short surge periods.

2. Ferrite designs have very low core loss, so design goals can concentrate on copper loss and preventing saturation. The downside is that the finished unit will almost surely be larger than a molypermalloy toroid design because of the basic topological limitations of the ferrite/bobbin arrangement. Newer low-profile ferrite cores are even less space efficient than older configurations.

Cost may also be higher. Ferrite core material saturates "hard," which means that inductance collapses abruptly when peak design current is exceeded. This may be a problem in current limit or if peak load requirements are not well characterized.

3. Molypermalloy (from Magnetics, Inc.) is a very good, low loss core material for toroids, but it is (naturally) rather expensive. A reasonable substitute is KoolM μ (same manufacturer). Toroids are very space efficient, especially when you can convince the manufacturer to use several layers of wire. Because they generally lack a bobbin, mounting is more difficult. Newer designs for surface mount are available (Coiltronics), which are nested in a ring that does not increase the height significantly.

Catch Diode

The catch diode carries load current only during switch "off" time. Its average current is therefore dependent on switch duty cycle. At high input voltages, the diode conducts most of the time, and as V_{IN} approaches V_{OUT} , it conducts only a small fraction of the time. The current rating of the diode should be higher than maximum load current for two reasons. First, conservative diode current improves efficiency because the diode forward voltage is lower, and second, short circuit conditions result in near 100% diode duty cycle at currents higher than full load unless some form of foldback current limiting is used. Schottky diodes are a must for their low forward drop and fast switching times.

Maximum diode reverse voltage is equal to maximum input voltage. However, do not over-specify the diode for breakdown voltage. Schottky diodes are made with lighter silicon doping as breakdown ratings increase. This gives higher forward voltage and degrades regulator efficiency. An MBR350 (3A, 50V) has almost 100mV higher forward voltage than the MBR330 (3A, 30V).

Diode current ratings are predicated on proper thermal mounting techniques. Check the manufacturers assumptions carefully before assuming that a 3A diode is actually capable of carrying 3A continuously. Pad size may have to be larger than normal to meet the mounting requirements for full current capability.

APPLICATIONS INFORMATION

Input Supply Bypass Capacitor

The input capacitor on a step-down (buck) switching regulator must handle switching currents with a peak-to-peak amplitude at least equal to the output current. The RMS value of capacitor current is approximately equal to:

$$I_{\text{RMS}} = \frac{I_{\text{OUT}} [V_{\text{OUT}} (V_{\text{IN}} - V_{\text{OUT}})]^{1/2}}{V_{\text{IN}}}$$

This formula has a maximum at $V_{\text{IN}} = 2V_{\text{OUT}}$, where I_{RMS} is equal to $I_{\text{OUT}}/2$. This simple worst case condition is commonly used for design because even significant deviations from $V_{\text{IN}}/2$ do not offer much relief. A 2A output (transient loads can be ignored if they last less than 30 seconds) therefore requires an input capacitor with a 1A ripple current rating. *Don't cheat*, and read the output capacitor section for details on ripple current! The input capacitor may well be the largest component in the switching regulator. Spend time playing with aspect ratios of various capacitor families and don't hesitate to parallel several units to achieve a low profile.

Output Voltage Ripple

Output voltage ripple is determined by the main inductor value, switching frequency, input voltage, and the ESR (effective series resistance) of the output capacitor. The following formula assumes a load current high enough to establish continuous current in the inductor.

Output Ripple Voltage = $V_{\text{p-p}}$

$$= \frac{V_{\text{OUT}} (V_{\text{IN}} - V_{\text{OUT}}) (\text{ESR})}{V_{\text{IN}} (f) (L)} V_{\text{p-p}}$$

With $V_{\text{IN}} = 12\text{V}$, $\text{ESR} = 0.05\Omega$, $f = 60\text{kHz}$, and $L = 50\mu\text{H}$

$$V_{\text{p-p}} = \frac{5(12 - 5)(0.05)}{(12)(60\text{E}^3)(50\text{E}^{-6})} = 48.6\text{mV}_{\text{p-p}}$$

If low output ripple voltage is a requirement, larger output capacitors and/or inductors may not be the answer. An output filter can be added at modest cost which will attenuate ripple much more space-effectively than an oversized output capacitor or inductor. The thing to keep

in mind when adding an output filter is that if the filter capacitor is small, it may allow large output perturbations if large load transients occur. This effect should be carefully checked before finalizing any filter design. For more details on output filters, consult Application Notes 19 and 44.

Output Capacitor

To avoid overheating, the output capacitor must be large enough to handle the ripple current generated by the main inductor. It must also have low enough effective series resistance (ESR) to meet output ripple voltage requirements. RMS ripple current in the output capacitor is given by:

$$I_{\text{RIPPLE(RMS)}} = \frac{V_{\text{OUT}} (V_{\text{IN}} - V_{\text{OUT}})}{3.5 V_{\text{IN}} (f) (L)}$$

(use maximum V_{IN})

For $V_{\text{IN}} = 15\text{V}$, $f = 60\text{kHz}$, $L = 50\mu\text{H}$,

$$\begin{aligned} I_{\text{RIPPLE(RMS)}} &= \frac{5(15 - 5)}{3.5(15)(60\text{E}^3)(50\text{E}^{-6})} \\ &= 0.32\text{A}_{\text{RMS}} \end{aligned}$$

Ripple current ratings are specified on capacitors intended for switching applications, but the number is subject to much manipulation. The high frequency number is greater than the low frequency value, and theoretically one can multiply the ripple number by significant amounts at temperatures below the typical 85°C or 105°C rating point. The problem is that the ripple ratings are already unrealistically high at the rated temperature because they are typically based on a 2000 hour life. I assume this is an unacceptable lifetime number, so the ripple rating must be *reduced* to extend life. The net result of all this fiddling with the numbers is generally a headache, but it is probably conservative to use the stated high frequency rating at temperatures below 60°C for a 105°C capacitor, and assume that the unit will last at least 50,000 hours. Remember to factor in *actual* operating time at elevated temperatures. Laptop computers, for instance, might be expected to operate no more than four hours a day on

APPLICATIONS INFORMATION

average, so a ten year life is only 15,000 hours. The manufacturer should be consulted for a final blessing. See Application Note 46 for specific formulas for calculating the life time or allowed ripple current in capacitors.

The reason for all this attention to ripple rating is that everyone is in a size squeeze, and the temptation is to use the smallest possible components. Do not cheat here folks, or you may be faced with costly field failures.

ESR on the output capacitor determines output voltage ripple, so this is also of much concern. Mother Nature has decreed that for a given capacitor technology, ESR is a direct function of the *volume* of the capacitor. In other words, if you want low ESR you must consume *space*. This is quickly confirmed by scanning the ESR numbers for a wide range of capacitor values and voltage ratings within a given family of capacitors. It is immediately obvious that can size determines ESR, not capacitance, or voltage rating. The only way to cheat on this limitation is to find the best family of capacitors. Manufacturers such as Nichicon, Chemicon, and Sprague should be checked. Sanyo makes a very low ESR capacitor type know as OSCON, utilizing a semiconductor dielectric. Its major disadvantage is somewhat higher price, and a tendency to make regulator feedback loops unstable because of its extremely low ESR. Most switching regulator loops depend to some extent on the output capacitor ESR for a phase lead!

Output Filters

Output ripple voltage at the switching frequency is a fact of life with switching regulators. Everyone knows that this ripple must be held below some level to guarantee that it does not affect system performance. The question is, what is that level? For sensitive analog systems with wide bandwidths, supply ripple may have to be a 1mV or less. Digital systems can often tolerate 400mV_{p-p} ripple with no effect on performance. In most of these digital applications of the LT1432 as a buck converter, an output filter is not needed because output ripple is normally in the 25mV to 100mV_{p-p} range without a filter. Note that burst mode ripple is at low frequencies where small output filters are not effective. The decision to add an output filter does allow the main filter capacitor to get smaller, so the overall

board space may not increase prohibitively. See the discussion of waveforms for load transient response implications when adding a filter.

If modest reductions in output ripple are required, one can increase the size of the main inductor and/or the output capacitor. Buck converters are easier than other types because the main inductor acts as a filter element. The square wave voltage is converted to a triangular current before being fed to the output capacitor. Actually, at switching frequencies, the output capacitor is resistive and output ripple voltage is determined not by the capacitor value in μF , but rather by the capacitor effective series resistance (ESR). This parameter is determined by capacitor volume within any given family, so to get ESR down, one must still use a “bigger” capacitor. The problem is that often the main inductor/capacitor becomes physically too large if low output ripple is needed. Inverters, such as the positive to negative converter, tend to have much higher output ripple voltage because the main inductor is not a filter element – it simply acts as an energy storage device for shuttling essentially square wave currents from input to output. Unlike the buck converter, these currents can be much higher in amplitude than the output current.

An output filter of very modest size can reduce normal mode output ripple voltage by a factor of ten or more. The formula for filter attenuation in buck converters and inverters is shown below.

$$\text{Attenuation} = \frac{\text{ESR}}{8(L)(f)} \quad (\text{BUCK CONVERTER})$$

$$\text{Attenuation} = \frac{(\text{ESR})}{4(L)(f)} \quad (\text{INVERTER})$$

(The factor “4” is an approximation assuming worst case duty cycle of 50%)

A 10 μH , 100 μF (ESR = 0.4 Ω) filter on a buck converter using a 60kHz LT1271 will give an attenuation of:

$$\frac{0.4}{8(10\text{E}^{-6})(60\text{E}^3)} = 0.083$$

APPLICATIONS INFORMATION

100mV output ripple on the main capacitor will be reduced to $(0.083)(100) = 8.3\text{mV}$ at the output of the filter.

Layout Considerations

Although buck converters are fairly tolerant with regard to layout issues, there are still several important things to keep in mind. Most of these revolve around spikes created by switching high currents at high speeds. If 3A of current is switched in 30ns, the rate of change of current is $10\text{E}8\text{ A/S}$. Voltage generated across wires will be equal to this rate multiplied by the approximate 20nH per inch of wire. This calculates to 2V per inch of wire or trace!! Needless to say, connections should be kept short if the circuitry connected to these lines is sensitive to narrow spikes.

1. The input bypass capacitor must be kept as close to the switcher IC as possible, and its ground return must go directly to the ground plane with no other component grounds tied to it. The output capacitor should also connect directly to the ground plane.

2. The frequency compensation components shown in Figure 1 (R1 + C4, and C5) and the feedback pin bypass capacitor (C6) are shown connected to the floating ground pin of the IC switcher. This ground pin is also the high current path for the switch. To avoid differential spikes being coupled into the V_C and FB pins, these components must tie together and then be connected through a direct trace to the IC switcher ground pin. No other components should be connected anywhere on this trace and the trace area should be minimized. A separate wide trace must be used to connect the IC ground pin to the catch diode and inductor. Smaller traces can be used to connect the floating supply capacitor (C3) and the diode pin of the LT1432 to the wide trace reasonably close to the IC ground pin.

3. Traces which carry high current must be sized correctly. To limit temperature rise to 20°C , using 1oz copper, the trace width must be 20 mils for each ampere of current. 1/2oz copper requires 30 mils/A. These high current paths include the IC switcher ground pin and switch pin, the inductor, the catch diode, the current limit sense resistor, and the input bypass capacitor. If vias are used to connect these components on multiple layer

boards, their maximum rated current must also be considered. For currents greater than 1A, multiple vias may have to be used.

4. The catch diode has large square wave currents flowing in it. Connect the anode directly to the ground plane and the cathode directly to the IC ground pin.

5. The ground pin of the LT1432 is the reference point for output voltage. It should be routed separately to power ground as near to the load as is reasonable.

Transient Response

Load transient response may be important in portable applications where parts of the system are switched on and off to save power. There are two types of problems that differ by time scale. The first occurs very rapidly and is caused by the surge current created in charging the supply bypass capacitors on the switched load. This can be a very serious problem if large ($>0.1\mu\text{F}$) capacitors must be charged. No regulator can respond fast enough to handle the surge if the load switch on-resistance is low and it is driven quickly. The solution here is to limit the rise time of the switch drive so that the load rise time is limited to approximately $25 \times C_{\text{LOAD}}$. A $1\mu\text{F}$ load capacitor would require a $25\mu\text{s}$ load rise time, etc. This limits surge to about 200mA. This time frame is still too quick for a switching regulator to adjust to, but the surge is limited to a low enough value that the output capacitor will attenuate the surge voltage to an acceptable level.

A second problem is the change in DC load current. Switching regulators take many switching cycles to respond to sudden output load changes. During this time, the output shifts by an amount equal to $\Delta\text{load} (\text{ESR} + t/C)$, where ESR is the series resistance of the output capacitor, t is the time for the regulator to shift output current, and C is the output capacitor value. For example, if the load change is 0.5A, ESR is 0.1Ω , t is $30\mu\text{s}$, and $C = 390\mu\text{F}$, the shift in output voltage would be:

$$\Delta V_{\text{OUT}} = 0.5\text{A} \left(0.1\Omega + \frac{30\mu\text{s}}{390\mu\text{F}} \right) = 0.088\text{V}$$

APPLICATIONS INFORMATION

Figure 17 shows the effect of a 500mA transient load (0.3A to 0.8A) on the LT1432, both with and without an output filter. The top trace with no filter shows about a 60mV deviation with a settling time of 300μs. Astute switching regulator designers may notice the lack of switching ripple in this trace. To make a clean display the actual trace was fed through a one pole filter with 16μs time constant to eliminate most of the switching ripple. This had very little effect on the shape or amplitude of the response waveform (you'll have to trust me on this one). In the middle trace, an output filter of 10μH and 200μF was added to the regulator to achieve very low output ripple. The load transient response is obviously degraded because the second filter capacitor, following normal design practice, is somewhat smaller than the main output capacitor, and therefore also has higher ESR. Note the slight ringing caused by the "Q" of the output filter. Calculated ringing frequency is $1/(2\pi\sqrt{LC}) = 3.4\text{kHz}$. Also note the small step in DC level between the two load conditions on the filtered output. To maintain good loop stability, the added filter is left "outside" the feedback loop. Therefore, the DC resistance of the 10μH inductor will add to load regulation. The 10mV step implies a resistance of $10\text{mV}/0.5\text{A} = 0.02\Omega$. The message in all this is to be careful when adding output filters if transient load response or load regulation is critical. The second filter capacitor may have to be as large as the main filter capacitor.

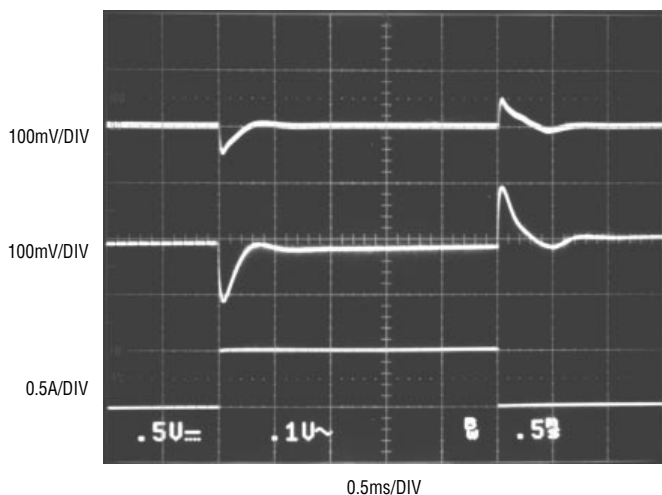

Figure 17

Mode Pin Drive

The mode pin defines operating conditions for the LT1432. A low state programs the IC to operate in "normal" mode as a constant frequency, current mode, buck converter. Floating the pin converts the internal error amplifier to a comparator which puts the LT1432 into a low-power "burst" mode. In this mode, the pin assumes an open circuit voltage of approximately 1V. To ensure stable operation, current into or out of the pin must be limited to 2μA. If the pin is routed near any switching or logic signals it should be bypassed with a 200pF capacitor to avoid pickup.

Driving the mode pin high causes the LT1432 to go into complete shutdown. An internal resistor limits mode pin current to about 15μA at 5V. A 7V zener diode is also in parallel with the pin, so input voltages higher than 6.5V must be externally limited with a resistor. The current/voltage characteristics of the mode pin are shown in Typical Performance Characteristics. Note that the drive signal must sink about 30μA when pulling the mode pin to its worst case low threshold of 0.6V. This should not be a problem for any standard open drain or three-state output.

If all three states are desired and a three-state drive is not available, the circuit shown in Figure 18 can be used. Two separate logic inputs are used. Both low will allow the mode pin to float for burst mode. "A" high, "B" low will generate shutdown, and "B" high, "A" low forces normal mode operation. Both high will also force normal mode operation, but this is not an intended state and R1 is included to limit overload of "A" if this occurs. C1 is suggested if the mode pin line can pick up capacitively coupled stray switching or logic signals.

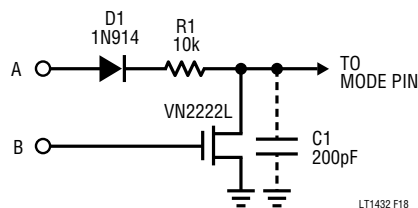

Figure 18. Two Input Mode Drive

APPLICATIONS INFORMATION

Internal Restart Sequence

At very light load currents (>10mA), coupled with low input voltages (<8.5V), it is possible for the basic architecture used by the LT1432 to assume a stable output state of less than 5V. To avoid this possibility, the LT1432 has an internal timer which applies a temporary 20mA load to the output if the output is below its regulated value for more than 1.8ms. This action is normally transparent to the user.

Auxiliary Outputs – “Free” Extra Voltages

Semi-regulated secondary outputs may be added to buck converters by adding additional windings to the main inductor. These outputs will have a typical regulation of 5 to 10%, but have one very important limitation. *The total output power of the auxiliary windings is limited by the output power of the main output.* If this limit is exceeded, the auxiliary winding voltages will begin to collapse, although the main 5V output is unaffected by collapse of the secondary. The auxiliary power available is also a function of input voltage. At higher input voltages significantly more power is available.

Figure 19 shows the ratio of maximum auxiliary power to main output power, versus input voltage. The auxiliary output was loaded until its output voltage dropped 10%. For applications which push the limit of theoretically available current, care should be used in winding the inductor. The effects of leakage inductance and series resistance are magnified at low input voltage where auxiliary winding currents are many times DC load current. Also, be aware that output voltage ripple on the 5V main output can increase significantly when the auxiliary output is heavily loaded. The inductor is acting partially like a transformer, so the AC current delivered to the 5V output capacitor increases in amplitude and shifts from a tri-wave to a trapezoid with much faster edges.

A typical example would be a +5V buck converter with a minimum load of 500mA. Output power is $5V \times 0.5A = 2.5W$. Maximum power from the auxiliary windings would be 1.25W for input voltages of 9V and above. If we assume a low dropout linear regulator on the auxiliary output, with

a regulated output voltage of minus 5V, the auxiliary winding output would have to be about minus 7V. Maximum output current from the 7V output would be $1.25W/7V = 178mA$. Note that the power restriction is the *total* for all auxiliary outputs.

The formula to calculate turns ratio for the auxiliary windings versus main winding is simple:

$$N_{AUX} = \frac{N_{MAIN} [V_{AUX} + (V_{DO} = 2V) + V_{DA}]}{5V + V_D}$$

N_{MAIN} = Number of turns on main inductor winding

N_{AUX} = Number of turns on auxiliary winding

V_{DA} = Auxiliary diode forward voltage

V_D = Main 5V catch diode forward voltage

V_{DO} = Allowance for regulation of auxiliary winding and dropout voltage of low-dropout linear regulator used on auxiliary winding. Set equal to zero if no regulator is used.

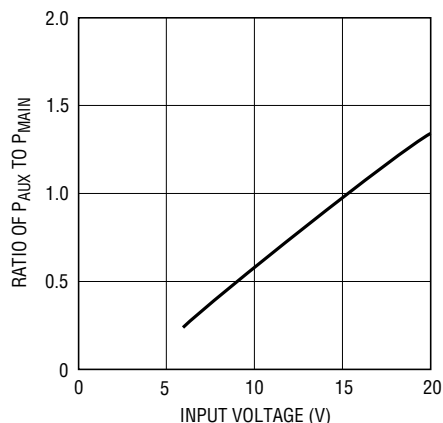

Figure 19. Auxiliary Power vs 5V Power

It is not necessary to use a linear regulator on the auxiliary winding if 5 to 10% regulation is adequate. Line regulation will be fairly good, but variations in auxiliary voltage will occur with load changes on either the auxiliary winding or the 5V output. For relatively constant loads, regulation will be significantly better.

APPLICATIONS INFORMATION

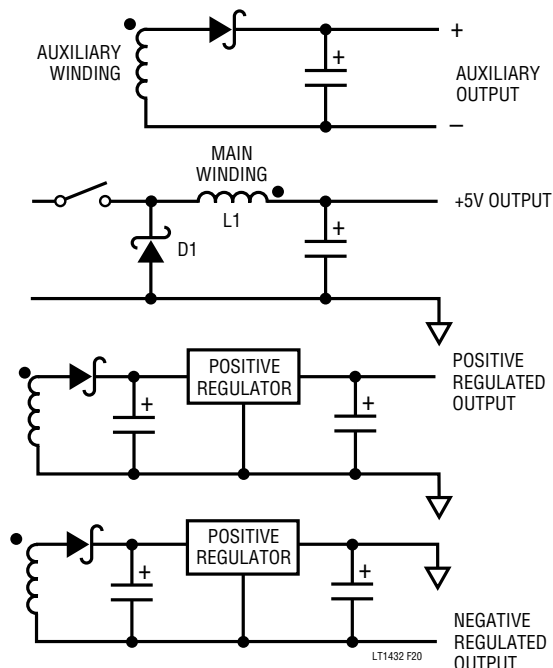

Figure 20

Figure 20 shows how to connect the auxiliary windings. Dots indicate winding polarity. Pay attention here -- history shows that with a 50% chance of connecting up the auxiliary correctly when you ignore the dots, in actual practice you will be wrong 90% of the time.

The floating output can have either end grounded, depending on the need for a positive or negative output. Also shown are the connections for both positive and negative outputs using a linear regulator. Note that the two circuits are identical! The floating auxiliary winding allows the use of a positive low-dropout regulator for negative outputs. These positive regulators are more readily available, especially at lower current levels.

There is a way to “cheat” somewhat on auxiliary power for positive outputs higher than the 5V main output. The auxiliary winding return can be connected to the 5V output. This reduces the winding voltage so that more current is available, and at the same time it actually adds

a load to the 5V output to bootstrap itself. Figure 21 shows maximum current out of a 14V auxiliary (used to power a 12V linear regulator) connected in this fashion. The auxiliary winding voltage is actually 9V. Note that for lighter 5V loads, there is an inflection point in the curves at about 11V. That is because theoretically the bootstrapping effect should allow one to draw *unlimited power* from the auxiliary winding when duty cycle exceeds 50%. The actual available current above 50% duty cycle is limited by parasitic losses. At high 5V loads, the inflection disappears for the same reason. The curves asymptotically approach 1 amp at high input voltage because the criteria used to generate the curves was a drop in auxiliary output voltage to 13.5V, and again parasitic resistance limits output current.

Auxiliary windings deliver current in triangular or quasi-square waves only during switch off time. Therefore the amplitude of these pulses will be somewhat higher than the DC auxiliary load current, especially at low input voltage. This means that in the “stacked” connection, ripple voltage on the 5V output will increase with auxiliary load current.

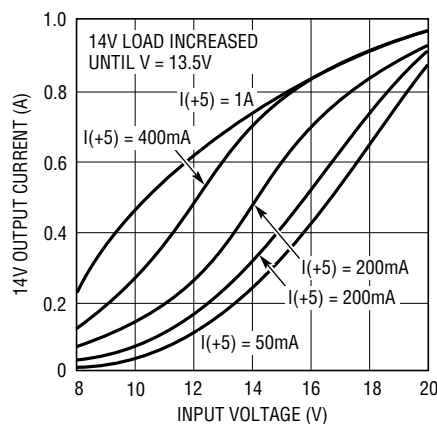

Figure 21

POSITIVE TO NEGATIVE CONVERTER

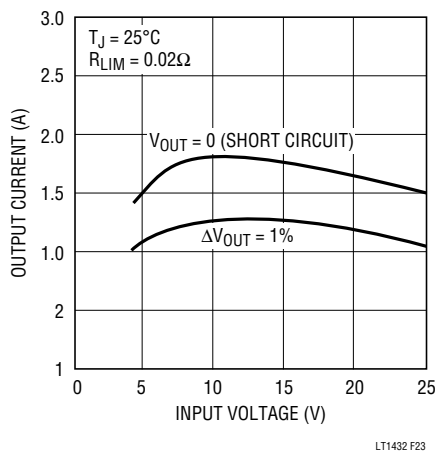

Figure 23. Positive-to-Negative Converter Output Current

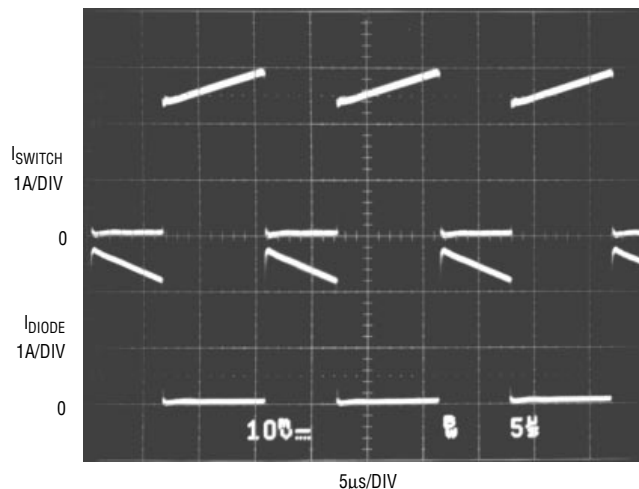

Figure 24. Positive-to-Negative Converter Switch and Diode Current

tor current is diverted through the catch diode to the output. Figure 24 shows switch current (1A/DIV) with the upper waveform, and catch diode current (which is delivered to the output) in the lower waveform, with a +5V input and 1A load. Note that switch, inductor, and diode currents are much higher than output current as required by the fact that current is delivered to the output during only part of a switch cycle. An approximate formula for peak switch current required in an inverting design is:

$$I_{SW(PEAK)} = I_{OUT} \left(1 + \frac{V_{OUT} + V_F}{V_{IN} - I_{OUT}(R_{SW}) \left(\frac{V_{IN} + V_{OUT}}{V_{IN}} \right)} \right) + \frac{V_{IN}(V_{OUT})}{2(L)(f)(V_{IN} + V_{OUT})}$$

V_F = Forward voltage of catch diode

R_{SW} = Switch on-resistance

L = Inductor value

f = Switching frequency

If V_{IN} is 4.7V (minimum),

$V_F = 0.4V$, $R_{SW} = 0.25\Omega$,

$L = 50\mu H$, $f = 60kHz$, and $I_{OUT} = 1A$;

$$I_{SW(PEAK)} = 1 \left(1 + \frac{5 + 0.4}{4.7 - 1(0.25) \left(\frac{4.7 + 5}{4.7} \right)} \right) + \frac{4.75(5)}{2(50E^{-6})(60E^3)(4.75 + 5)}$$

$$= 2.29 + 0.4 = 2.69A$$

The first term (2.29A) represents the minimum switch current required if the inductor were infinitely large. A finite inductor value requires additional switch current. The 0.4A represents one-half the peak-to-peak inductor ripple current. The end result is that peak switch current is almost three times output load current. This multiplier drops rapidly at higher input voltages, so worst case is calculated at lower input voltage.

Figure 25 shows the efficiency of this converter. At higher input voltages and modest output currents efficiency hovers around 85%, quite good for a 5V output inverter. Low input voltage reduces efficiency because of increased currents in the switch, catch diode, and inductor. High input voltage and low output current also show lower efficiency due to quiescent currents in the ICs. Note that the efficiency is actually significantly improved in this regard over a more conventional design because the

POSITIVE TO NEGATIVE CONVERTER

LT1271 operates from a constant 5V supply voltage rather than the high input voltage.

Output voltage ripple in an inverter can be much higher than a buck converter because current is delivered to the output capacitor in high amplitude square waves rather than a DC level with superimposed tri-wave. C2 is therefore somewhat larger than in a buck design. Also C2 must be rated to handle the large RMS current pulses fed into it. This RMS current is approximately equal to:

$$I_{OUT} \left(\sqrt{\frac{V_{OUT}}{V_{IN}}} \right)$$

For 1A output current, with 5V input, this computes to 1A_{RMS} in the output capacitor. A small additional output filter would reduce output ripple voltage, but it does not change the current rating requirement for the main output capacitor. The reader is referred to a switching regulator CAD program (SwitcherCAD) supplied by LTC for further insight into converters. It is suggested that the reader fool the program by asking for a negative input, positive output

design. It will then select the LT1070 family of ICs which normally are not used in positive to negative converters. Efficiency calculations will be somewhat in error at higher input voltages because the program assumes full input voltage across the IC. Later versions of SwitcherCAD will have a special section for this particular design.

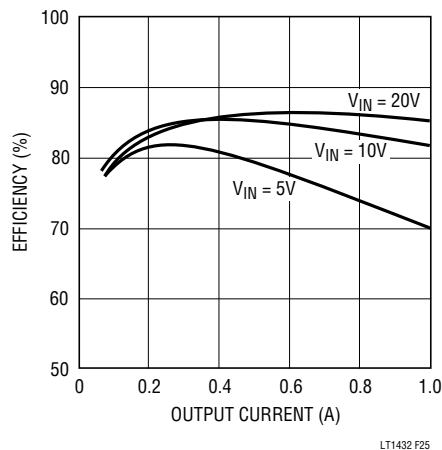
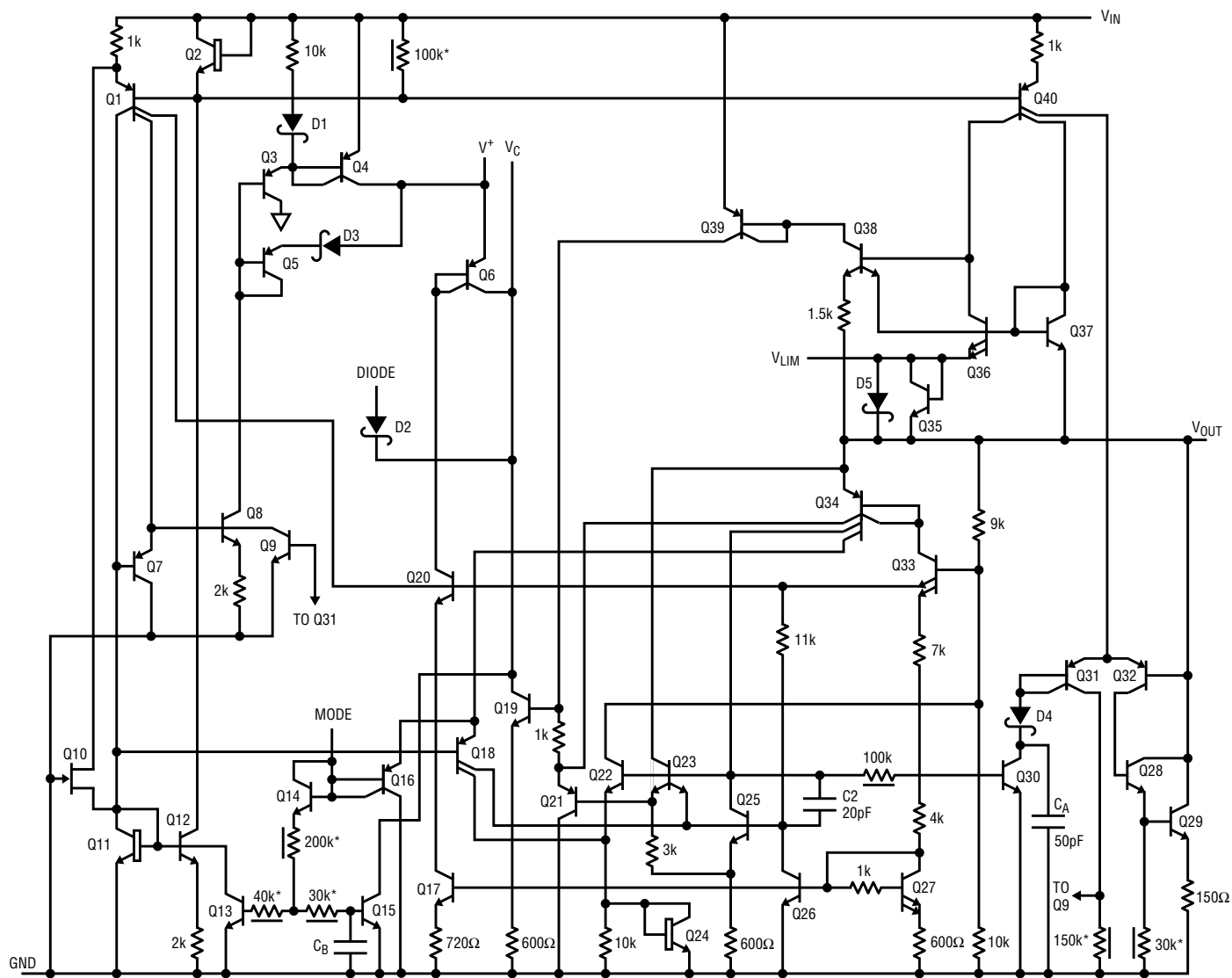

Figure 25. Positive-to-Negative Converter Efficiency

SCHEMATIC DIAGRAM



* — INDICATES PINCH RESISTOR

LT1432 F26

PACKAGE DESCRIPTION

**N8 Package
8-Lead Plastic DIP**

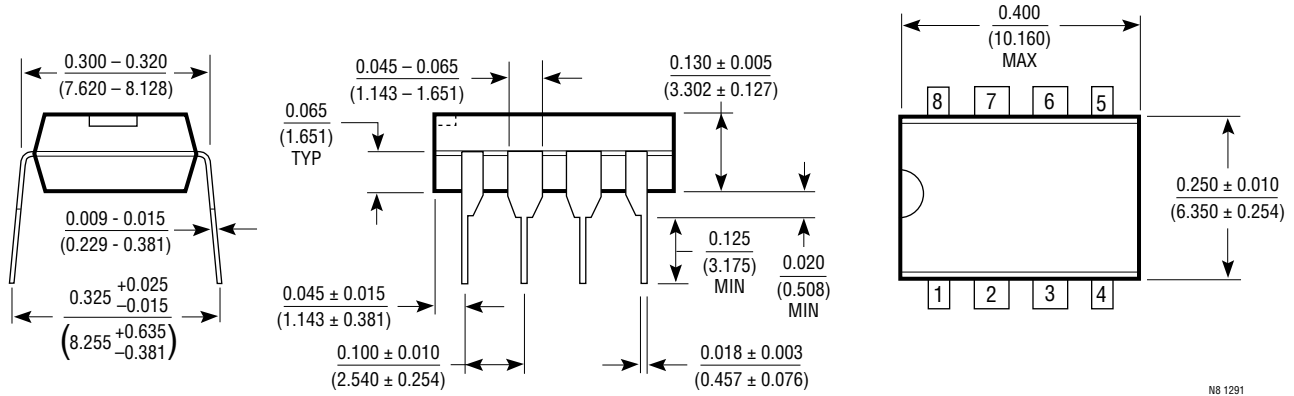

N8 1291

T _{JMAX}	θ _{JA}
100°C	150°C/W

**S8 Package
8-Lead Small Outline**

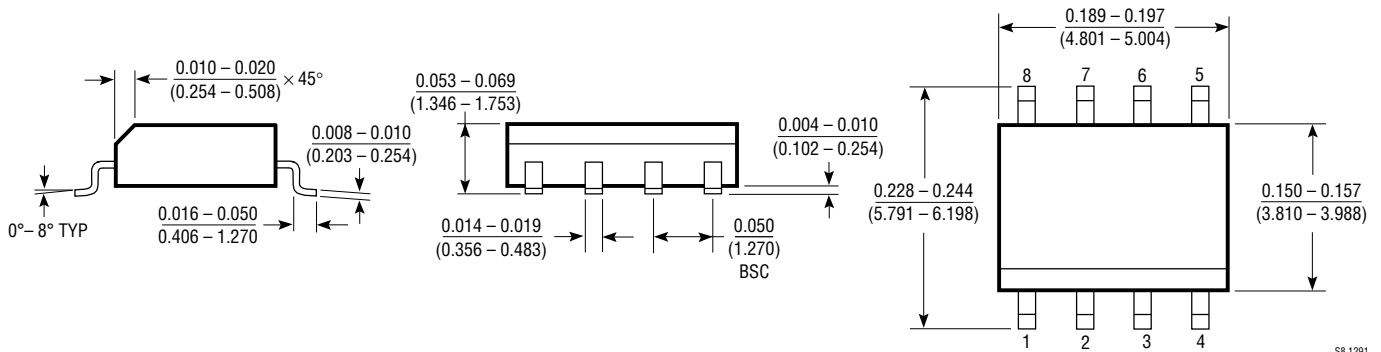

S8 1291

T _{JMAX}	θ _{JA}
100°C	170°C/W